

mitsubishi S6R-PTA

Click on the headlines below to get redirected to the respective sections in this document.

[GA drawing](#)
[Technical data](#)
[Elastic drawing](#)
[Exhaust gas emission](#)
[Fuel consumption](#)

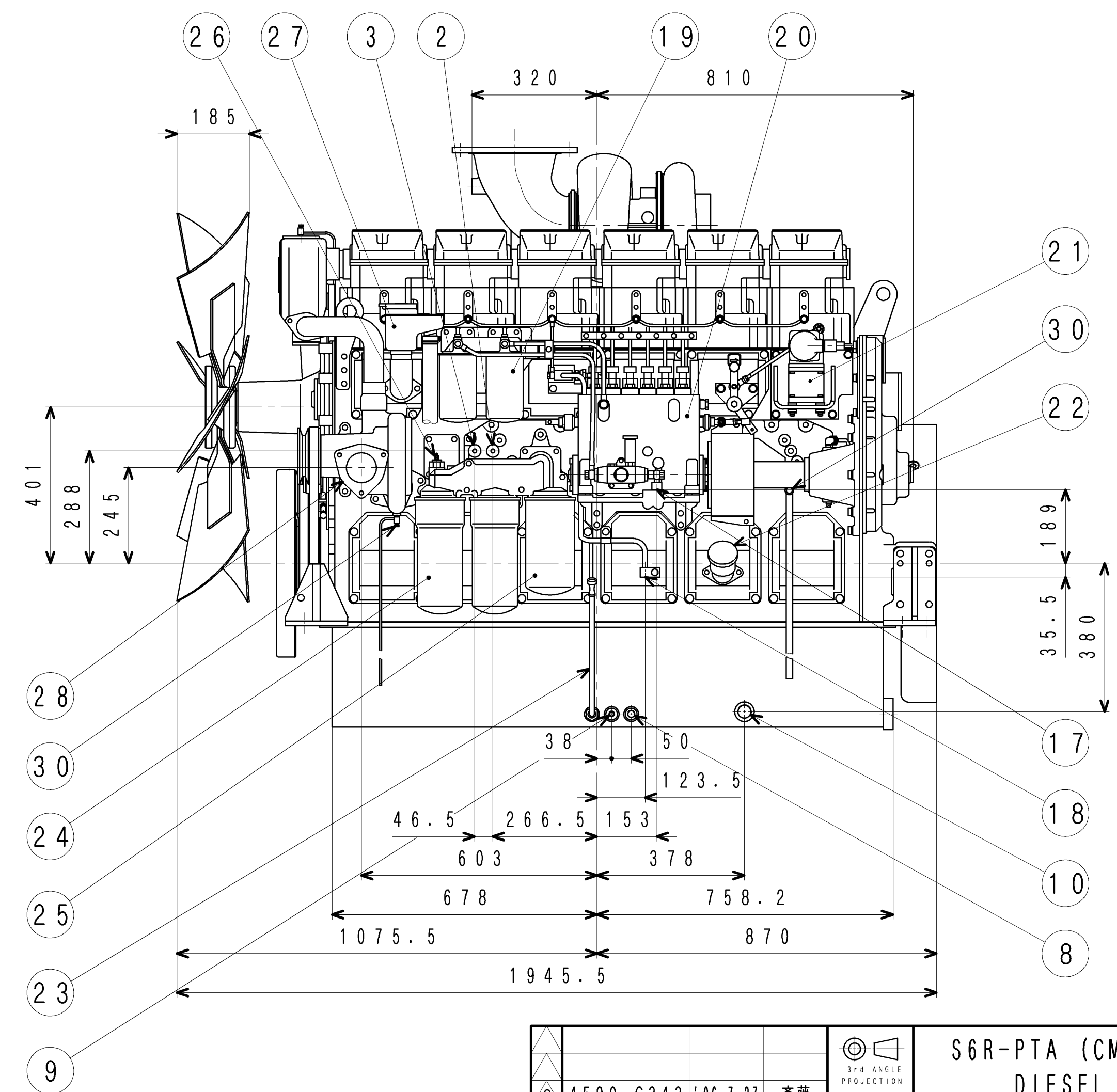
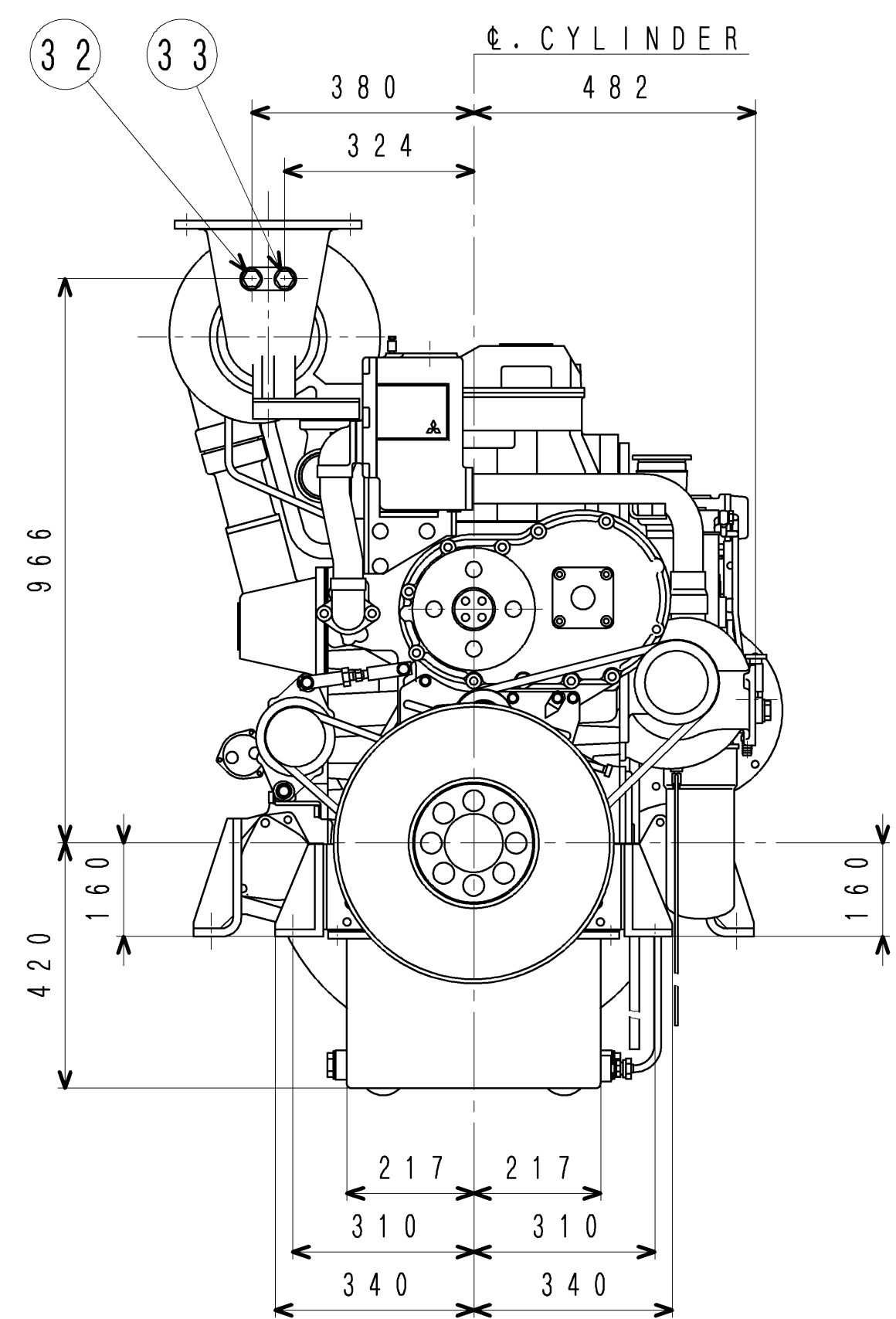
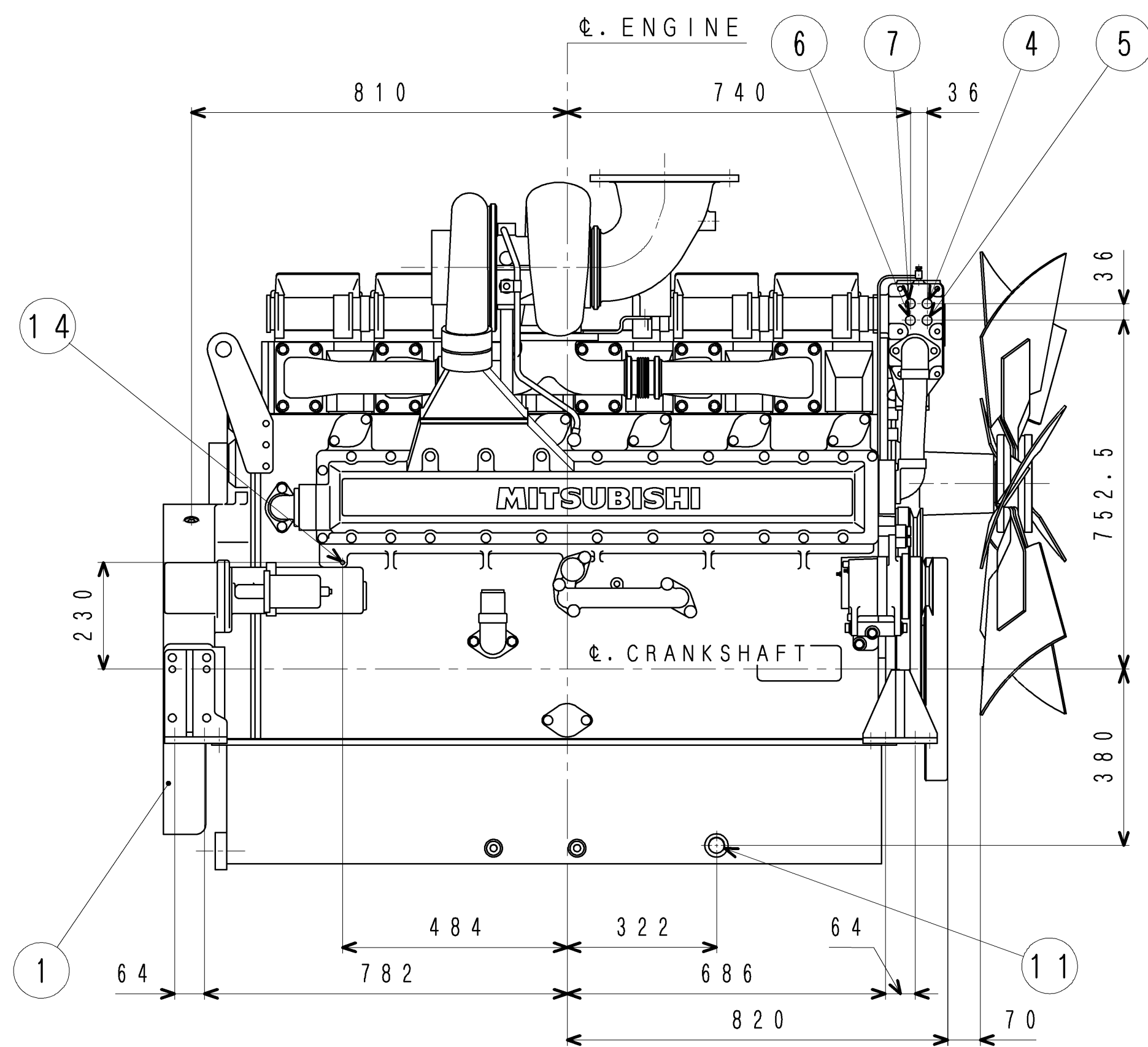
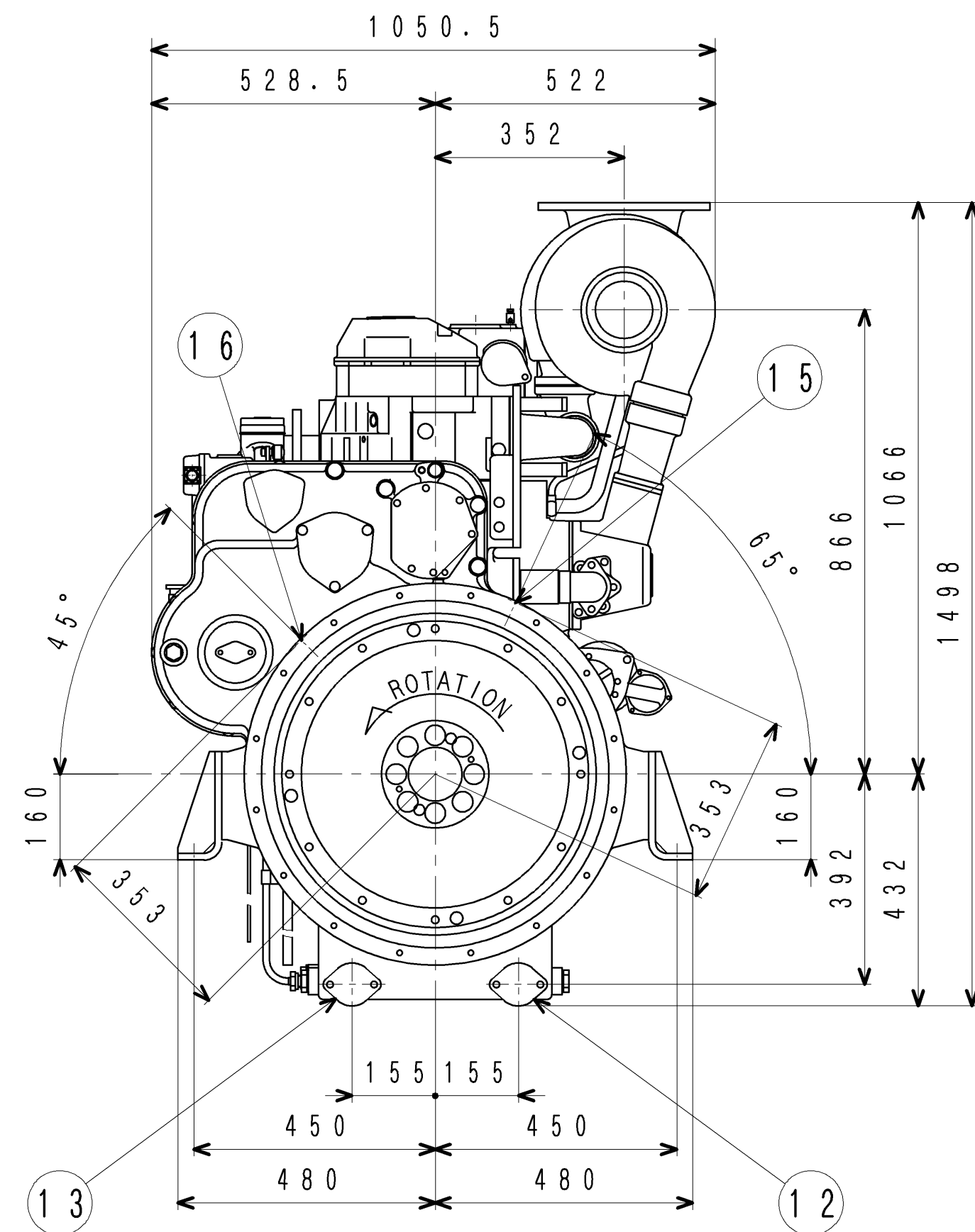
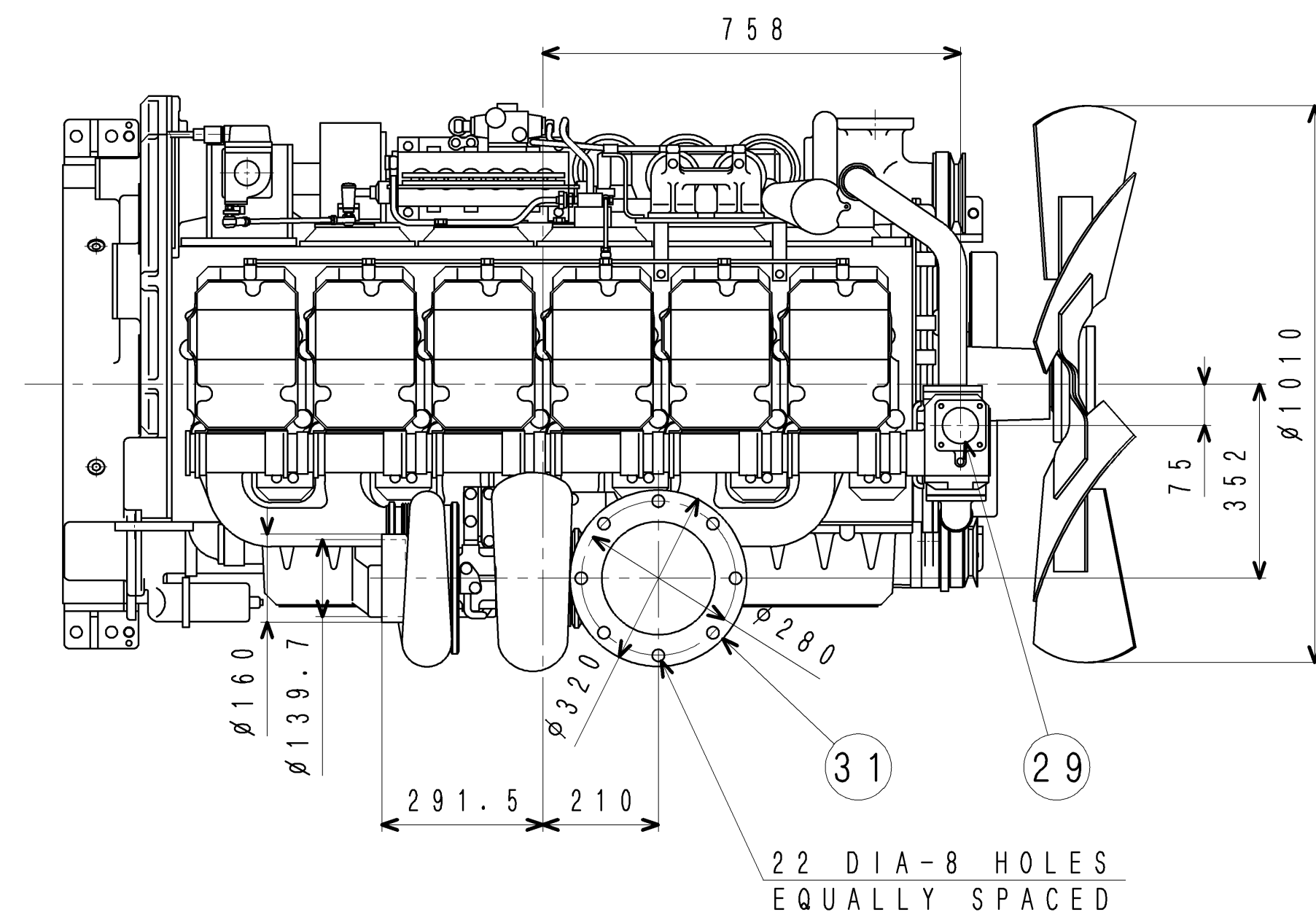

NO.	PARTS NAME	SIZE	REFERENCE
1	FLYWHEEL & HOUSING		37596-21001
2	OIL PRESS. GAGE UNIT JOINT	Rc1/8	37596-01020
3	OIL PRESS. SWITCH JOINT	Rc1/8	↑
4	THERMOMETER UNIT JOINT	Rc1/2	
5	THERMOSWITCH JOINT	Rc1/2	
6	THERMOSWITCH JOINT	Rc1/2	
7	THERMOSWITCH JOINT	Rc1/2	
8	OIL PAN (A) JOINT	M20x1.5	
9	OIL PAN (B) JOINT	M16x1.5	
10	OIL PAN (C) JOINT	M36x1.5	
11	OIL PAN (C) JOINT	M36x1.5	
12	OIL PAN (D) JOINT		
13	OIL PAN (D) JOINT		
14	AIR PRESS. GAGE JOINT	Rc1/4	
15	PICKUP JOINT	UNF5/8-18	
16	PICKUP JOINT	UNF5/8-18	
17	FUEL INLET PIPE JOINT	Rc3/8	↓
18	FUEL RETURN PIPE JOINT	Rc3/8	37596-01020
19	FUEL FILTER		
20	FUEL INJECTION PUMP		
21	GOVERNOR		
22	OIL FILLER		
23	OIL LEVEL GAGE		
24	OIL FULL-FLOW FILTER		
25	OIL BY-PASS FILTER		
26	OIL BY-PASS ALARM SWITCH		37596-01020
27	BREATHER		
28	WATER INLET PIPE JOINT		37596-01020
29	WATER OUTLET PIPE JOINT		37596-01020
30	WATER DRAIN COCK		
31	EXHAUST FLANGE	200A	
32	THERMOMETER, ex. JOINT	Rp3/4	37596-01020
33	THERMOMETER, ex. JOINT	Rp3/4	37596-01020

4590-C343 '06.7.27 斎藤		37596-01020	
4590-4865 '99.1.20 福田		37596-01020	
CHG	ED-NO	DATE	CHK
松本	竹谷	福田	谷藤
APPD	CHK	DRN	1388, 5, 7

37596-01020

S6R-PTA (CM-BR)
DIESEL ENGINE
三菱重工業株式会社 汎用機・特車事業本部
MITSUBISHI HEAVY INDUSTRIES, LTD. GENERAL MACHINERY & SPECIAL VEHICLE HEADQUARTERS.

図面番号 37596-00220
DRAWING NO. 37596-00220

1 新図 2 訂正 3 検査済品 4 組立品
5 旧図 6 他社(購入品)

旧引
汎特
2006
9.15

FULL-CAO



**MITSUBISHI DIESEL ENGINE
TECHNICAL INFORMATION**

ITEM NO.	T0214-0001E Rev.2 (1/4)
DATE	March, 2013

Specification Sheets of S6R-PTA Engine

Specification Sheets of S6R-PTA Engine are enclosed herein.

Revision	First Edition : September, 2007 (T13-0307-E Mar.'04)	Engine Engineering Department Engine System Designing Section		
	Rev.1 : Dec., 2012			
	Rev.2 : Mar., 2013	Approved by	Checked by	Drawn by
		T.HASHIGUCHI	T.OGURA	K.NAKAMURA

GENERAL ENGINE DATA

Type	4-Cycle, Water Cooled	
Aspiration	Turbo-Charged, After Cooler (Jacket water to Cooler)	
Cylinder Arrangement	Inline	
No. of Cylinders	6	
Bore mm(in.)	170	(6.69)
Stroke mm(in.)	180	(7.09)
Displacement liter(in ³)	24.51	(1496)
Compression Ratio	14.0:1	
Dry Weight - Engine only - kg(lb)	2800	(6174)
Wet Weight - Engine only - kg(lb)	2940	(6483)

PERFORMANCE DATA

Steady State Speed Stability Band at any Constant Load		
Electric Governor - %	±0.25 or better	
Maximum Overspeed Capacity - rpm	2100	
Moment of inertia of Rotating Components - N·m ² (lbf·ft ²)	375	(908)
(Includes Std. Flywheel)		
Cyclic Speed Variation with Flywheel at 1800rpm	1/164	
1500rpm	1/110	
1200rpm	1/76	

ENGINE MOUNTING

Maximum Bending Moment at Rear Face of Flywheel Housing - N·m(lbf·ft)	1961	(1447)
---	------	--------

AIR INLET SYSTEM

Maximum Intake Air Restriction (Includes piping)		
With Clean Filter Element - mm H ₂ O (in.H ₂ O)	400	(15.7)
With Dirty Filter Element - mm H ₂ O (in.H ₂ O)	635	(25.0)

EXHAUST SYSTEM

Maximum Allowable Back Pressure - mm H ₂ O (in.H ₂ O)	600	(23.6)
---	-----	--------

LUBRICATION SYSTEM

Oil Pressure at Idle - MPa(psi)	0.2~0.3	(29~43)
at Rate Speed - MPa(psi)	0.49~0.64	(71~93)
Maximum Oil Temperature of Oil pan- °C(°F)	110	(230)
Oil Capacity of Standard Oil pan High - liter (U.S.gal)	80	(21.1)
Low - liter (U.S.gal)	50	(13.2)
Total System Capacity (Includes Oil Filter) - liter (U.S.gal)	100	(26.4)
Maximum Angle of Installation (Std. Pan) Front Down	11.5°	
(Engine Only) Front Up	10°	
Side to Side	22.5°	

COOLING SYSTEM

Coolant Capacity (Engine only) - liter (U.S.gal)	50	(13.2)
Maximum External Friction Head at Engine Outlet - MPa(psi)	0.034	(5.0)
Maximum Static Head of Coolant above Crankshaft Center - m(ft)	10	(32.8)
Maximum Outlet Pressure of Engine Water Pump - MPa(psi)	0.25	(37.1)
Standard Thermostat (modulating) Range- °C(°F)	71~85	(160~185)
Maximum Coolant Temperature at Engine Outlet- °C(°F)	98	(208)
Minimum Coolant Expansion Space - % of System Capacity	10	
Maximum Coolant Temperature at Intercooler Inlet, TK type- °C(°F)		
Maximum Air Restriction on Discharge Side of Radiator and Fan-mm H ₂ O(in.H ₂ O)	10	(0.4)

The specifications are subject to change without notice.

APPLICATION : GENERATOR

Pub. No. T0214-0001E Rev.2 2/4

FUEL SYSTEM

Fuel Injector	Mitsubishi PS6 Type × 1
Maximum Suction Head of Feed Pump - mm Hg (in. Hg)	75 (3.0)
Maximum Static Head of Return & Leak Pipe - mm Hg (in.Hg)	150 (5.9)

STARTING SYSTEM

Battery Charging Alternator - V-Ah	24-30
Starting Motor Capacity - V -kW	24-7.5
Maximum Allowable Resistance of Cranking Circuit - m Ω	2.5
Recommended Minimum Battery Capacity	
At 5°C (41°F) and above - Ah	200
Below 5°C(41°F) through - 5°C(23°F)	500

The specifications are subject to change without notice.

APPLICATION : GENERATOR

Pub. No. T0214-0001E Rev.2 3/4

ENGINE RATING

All data represent net performance with standard accessories such as air cleaner, inlet /exhaust manifolds, fuel oil system, L.O. pump, etc. under the condition of 100kPa(29.6inHg) barometric pressure, 77°F(25°C) ambient temperature and 30% relative humidity.

ITEM	UNIT	STAND-BY POWER			PRIME POWER			CONTINUOUS C	CONTINUOUS D
		60Hz	50Hz	60Hz	60Hz	50Hz	60Hz	50Hz	50Hz
Engine Speed	rpm	1800	1500	1200	1800	1500	1200	1500	1500
No. of Cylinders		6							
Bore	mm (in.)	170 (6.69)							
Stroke	mm (in.)	180 (7.09)							
Displacement	liter (in. ³)	24.51 (1496)							
Brake Horse power without Fan	kW (HP)	655 (878)	570 (764)	420 (563)	595 (798)	515 (690)	380 (509)	445 (597)	395 (530)
Brake Mean Effective Pressure without Fan	MPa (psi)	1.8 (258)	1.9 (270)	1.7 (248)	1.6 (235)	1.7 (244)	1.6 (225)	1.5 (210)	1.3 (187)
Mean Piston Speed	m/s (ft/min)	10.8 (2126)	9.0 (1772)	7.2 (1417)	10.8 (2126)	9.0 (1772)	7.2 (1417)	9.0 (1772)	9.0 (1772)
Maximum Regenerative Power Absorption Capacity without Fan	kW (HP)	72 (97)	53 (71)	36 (48)	72 (97)	53 (71)	36 (48)	53 (71)	53 (71)
Intake Air flow	m ³ /min (CFM)	54 (1907)	47 (1660)	33 (1165)	49 (1730)	42 (1483)	29 (1024)	36 (1271)	33 (1165)
Exhaust Gas Flow	m ³ /min (CFM)	143 (5049)	123 (4343)	87 (3072)	130 (4590)	111 (3919)	78 (2754)	96 (3390)	86 (3037)
Coolant Flow	liter/min (U.S. GPM)	800 (211)	670 (177)	540 (143)	800 (211)	670 (177)	540 (143)	670 (177)	670 (177)
Coolant Flow to Intercooler (TK only)	liter/min (U.S. GPM)	—	—	—	—	—	—	—	—
Cooling Air Flow (Std. Fan)	m ³ /min (CFM)	720 (25423)	582 (20550)	444 (15678)	720 (25423)	582 (20550)	444 (15678)	582 (20550)	582 (20550)
Fan Loss Horse Power (Std. Fan)	kW (HP)	20 (27)	15 (20)	10 (14)	20 (27)	15 (20)	10 (14)	15 (20)	15 (20)
Radiated Heat to Ambient	kJ/hr (BTU/min)	170948 (2701)	146795 (2319)	103126 (1629)	155372 (2455)	132576 (2095)	92583 (1463)	114707 (1812)	102513 (1620)
Heat Rejection to Coolant	kJ/hr (BTU/min)	1424566 (22508)	1223289 (19328)	859387 (13578)	1294765 (20457)	1104803 (17456)	771526 (12190)	955895 (15103)	854274 (13497)
Heat Rejection to Inter Cooler (TK Version)	kJ/hr (BTU/min)	—	—	—	—	—	—	—	—
Heat Rejection to Exhaust	kJ/hr (BTU/min)	1745256 (27575)	1471677 (23252)	963340 (15221)	1586237 (25062)	1329134 (21000)	855294 (13513)	1149987 (18170)	1037219 (16388)
Noise Level (1 m height & distance) (excludes, Intake, Exhaust & Fan)	dB(A)	TBD	TBD	TBD	TBD	TBD	TBD	TBD	TBD

The specifications are subject to change without notice.

APPLICATION : GENERATOR

Pub. No. T0214-0001E Rev.2 4/4



**MITSUBISHI DIESEL ENGINE
TECHNICAL INFORMATION**

ITEM NO.

T0307-0005E Rev.2 (1/2)

DATE

May, 2008

Elastic data of S6R Engine

Elastic data of S6R Engine are enclosed herein.

Revision	First Edition : July, 2006 (Refer to ELASTIC-S6R-PTA Oct.,2003, S6R.0)	Engine Engineering Department Large Engine Design Section		
	Rev.1 : July, 2006 (Refer to MTD05-0002, S6R.0)	Approved by	Checked by	Drawn by
	Rev.2 : April, 2008 (Refer to MTD05-0003, S6R.0)	T.HASHIGUCHI	H.MIKAMI	H.M.

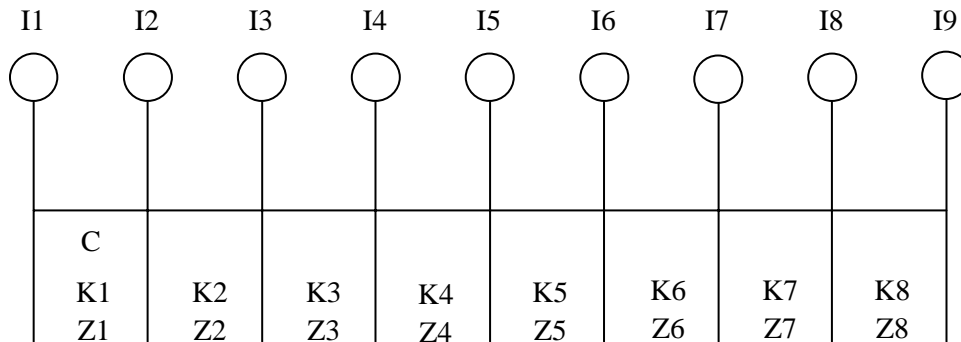

S6R-PTA ELASTIC DATA

(USE:45R89-19007 CONNECTING ROD)

(USE:45R89-20004 CRANKSHAFT)

	Moment of inertia J kg.m ²	Damping coefficient Nm/rad/s	Spring const. x10 ⁷ Nm/rad	Tensile strength N/mm ²	Section modulus cm ³
I1	DAMPER	1.11	C=524.7	K1=0	Z1 =0.0
I2	PULLEY	0.952	—	K2=1.196	Z2 =373.7
I3	No.1 CRANK	0.567	—	K3=0.755	Z3 =373.7
I4	No.2 CRANK	0.339	—	K4=0.755	Z4 =373.7
I5	No.3 CRANK	0.559	—	K5=0.755	Z5 =373.7
I6	No.4 CRANK	0.559	—	K6=0.755	Z6 =373.7
I7	No.5 CRANK	0.339	—	K7=0.755	Z7 =373.7
I8	No.6 CRANK	0.568	—	K8=1.206	Z8 =373.7
I9	FLYWHEEL 18in	5.59	—		

Hysteresis constant:123 No. of Cylinder: 6 Bore:170mm Stroke:180mm

Length of Con-Rod: 340mm Weight of Reciprocating Parts: 12.46 kg

Firing order:1-5-3-6-2-4

Firing interval:0-120-240-360-480-600

APPLICATION : LAND USE

The data is subject to change without notice.





**MITSUBISHI DIESEL ENGINE
TECHNICAL INFORMATION**

ITEM NO.

T0402-0001E Rev.1 (1/2)

DATE

May, 2008

Exhaust Gas Emission Data

Exhaust Gas Emission Data is enclosed herein.

These data are subject to change without notice.

Revision	First Edition : May, 2008	Engine Engineering Department Engine System Designing Section		
	Rev.1: February, 2013			
		Approved by	Checked by	Drawn by
		T.HASHIGUCHI	T.OGURA	K.N.

EXHAUST GAS EMISSION DATA OF DIESEL ENGINE FOR GENERATOR
For Reference

MODEL	S6A3-P/A		S12A2-P/A		S12H-P/A		S6R-P/A		S12R-P/A		S12R-PTA2		S12R-PTAA2 (W/FAN)		S16R-P/A		S16R-PTA2		S16R-PTAA2 (W/FAN)		S16R2-PTAW	
	400/ 1500	890	679/ 1500	825	935	930/ 1500	1020/ 1800	515/ 1500	1110/ 1500	1190/ 1800	1195/ 1500	1340/ 1800	1277/ 1500	1387/ 1800	1480/ 1500	1590/ 1800	1630/ 1500	1775/ 1800	1684/ 1500	1895/ 1800	2167/ 1500 *1	
Prime Rating kW/min ⁻¹ (without fan)																						
NOx	3.7	3.7	3.5	3.4	3.8	3.6	3.7	3.5	3.7	3.5	3.9	3.7	3.5	3.2	3.8	3.7	3.9	3.4	3.1	3.6		
CO	8.6	8.6	7.7	7.7	8.8	8.2	8.4	8.4	7.7	8.4	8.8	7.7	8.4	7.3	8.7	7.7	8.8	7.7	7.1	5.8		
HC	(220)	(210)	(220)	(210)	(310)	(210)	310	210	(310)	(210)	(310)	(210)	(320)	(200)	(310)	(210)	(210)	(320)	(200)	119		
CO ₂	6.7	6.2	6.7	6.2	6.9	6.5	8.0	7.1	6.9	6.5	6.7	6.5	6.7	6.5	6.7	6.5	6.7	6.5	6.5	8.0		
PM	0.12	0.12	0.12	0.11	0.12	0.11	0.10	0.10	0.12	0.11	0.10	0.09	0.09	0.08	0.11	0.12	0.11	0.09	0.07	0.03		
	0.37	0.37	0.38	0.37	0.38	0.37	0.34	0.35	0.35	0.37	0.34	0.33	0.33	0.31	0.33	0.33	0.33	0.33	0.31	0.04		

Notes

- Allowance: +25%
- Condition: 100kPa(750mmHg) barometric pressure, 298K(25°C) ambient temperature and 30% relative humidity.
- NOx, CO, HC[PPM]: with 13% O₂ Level.
NOx, CO, HC, Particulates[$\mu\text{g}/\text{Nm}^3$]: with 5% O₂ Level.
NOx, CO, HC, Particulates[$\mu\text{g}/\text{PS}\cdot\text{h}$]: with 13% O₂ Level.
CO₂[%]: Calculated Data.
(): Estimated Data.
- *1: Standby Rating
- *2: These data are subject to change without notice.





**MITSUBISHI DIESEL ENGINE
TECHNICAL INFORMATION**

ITEM NO.

T33-0100-E

DATE

Jun. 1999

FUEL CONSUMPTION

(SB, SA, SH, SR SERIES ENGINES FOR GENERATOR DRIVE)

ENGINE MODEL	ENGINE rpm	REMARKS
S6B-PTA, PTK	1500	W/Fan, W/O Fan
	1800	
S6B3-PTA, PTK	1200	W/Fan, W/O Fan
	1500	
S6A3-PTA, PTK	1200	W/Fan, W/O Fan
	1500	
S12A2-PTA, PTK	1200	W/Fan, W/O Fan
	1500	
S12H-PTA	1500	W/Fan, W/O Fan
	1800	
S6R-PTA, PTK	1200	W/Fan, W/O Fan
	1500	
S6R2-PTA, PTK	1000	W/Fan, W/O Fan
	1200	
S12R-PTA, PTK	1200	W/Fan, W/O Fan
	1500	
S12R-PTA2, PTK2	1500	W/Fan, W/O Fan
	1800	
S16R-PTA, PTK	1200	W/Fan, W/O Fan
	1500	
S16R-PTA2, PTK2	1500	W/Fan, W/O Fan
	1800	
S6A3-PTAA	1500	W/Fan
	1800	
S6R2-PTAA	1500	W/Fan
S12R-PTAA2	1500	W/Fan
	1800	
S16R-PTAA2	1500	W/Fan
	1800	

First Edition : Jun. 1999

Engine Engineering Department
Large Engine Design Section

Revision

Approved by

Checked by

Drawn by

SPECIFIC FUEL CONSUMPTION MODEL : S6B 1500rpm

- 1. STANDARD : ISO or JIS
- 2. ALLOWANCE : +5%

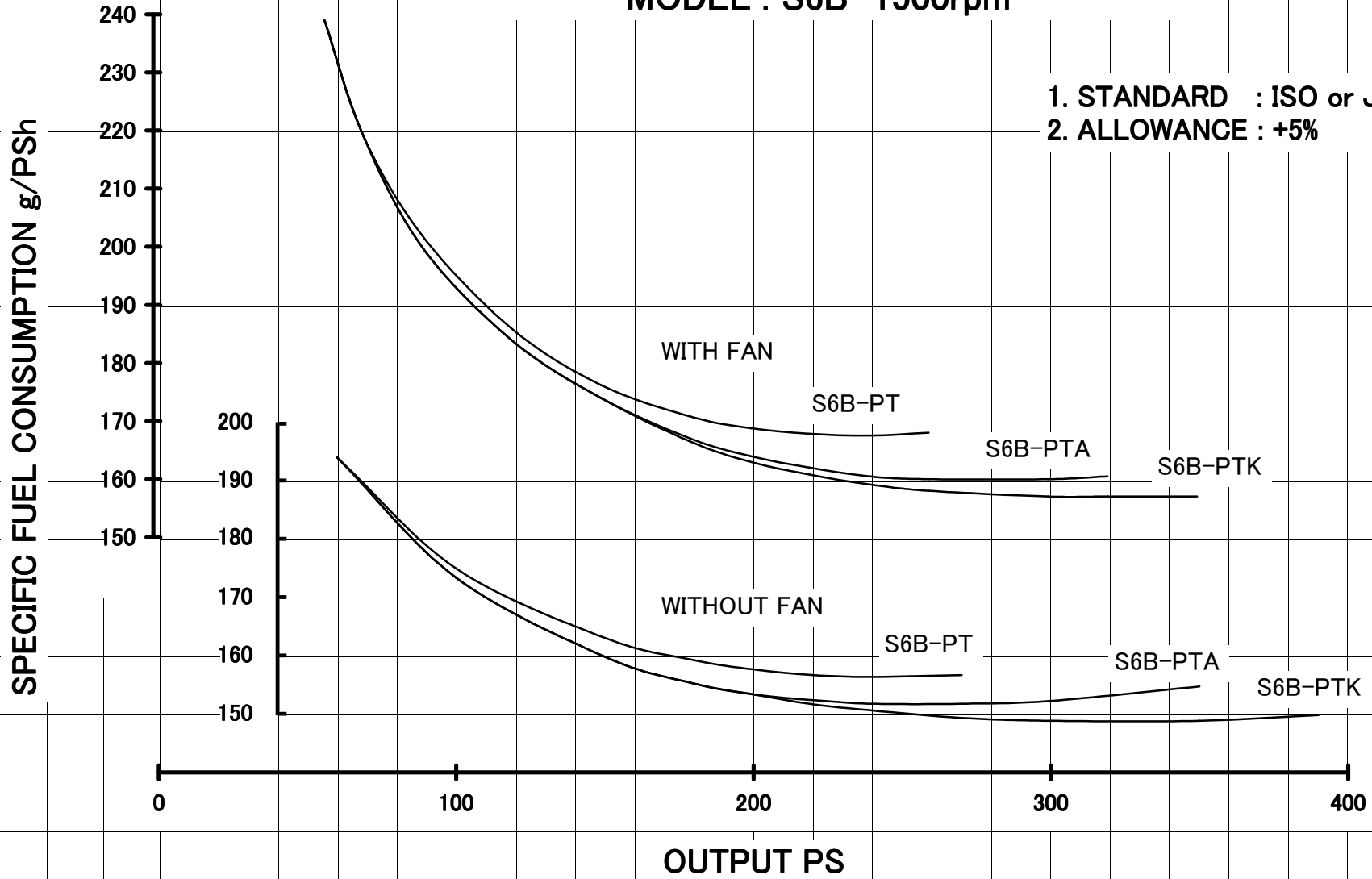

SPECIFIC FUEL CONSUMPTION MODEL : S6B 1800rpm

- 1. STANDARD : ISO or JIS
- 2. ALLOWANCE : +5%

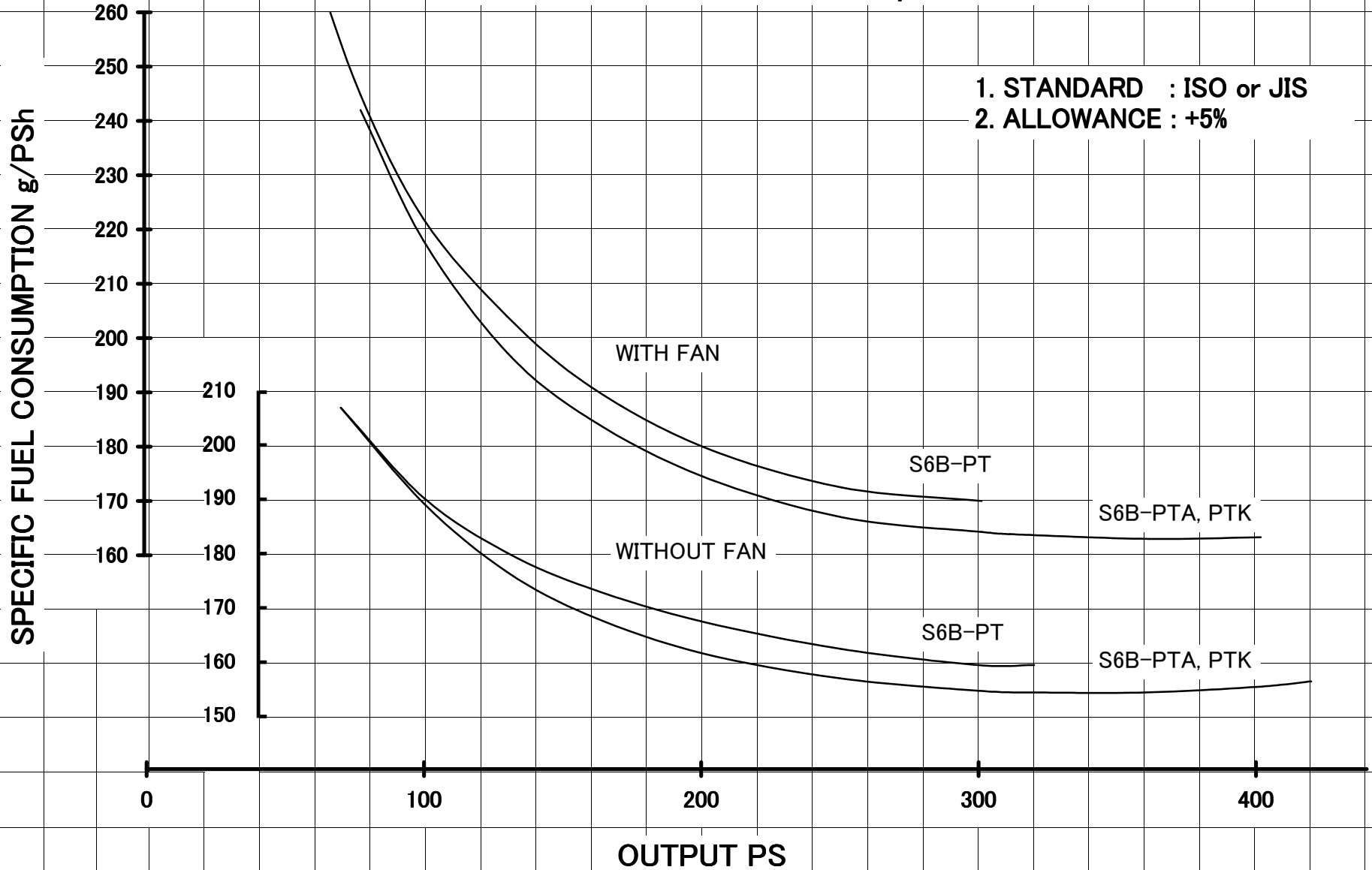

SPECIFIC FUEL CONSUMPTION MODEL : S6B3 1200rpm

- 1. STANDARD : ISO or JIS
- 2. ALLOWANCE : +5%

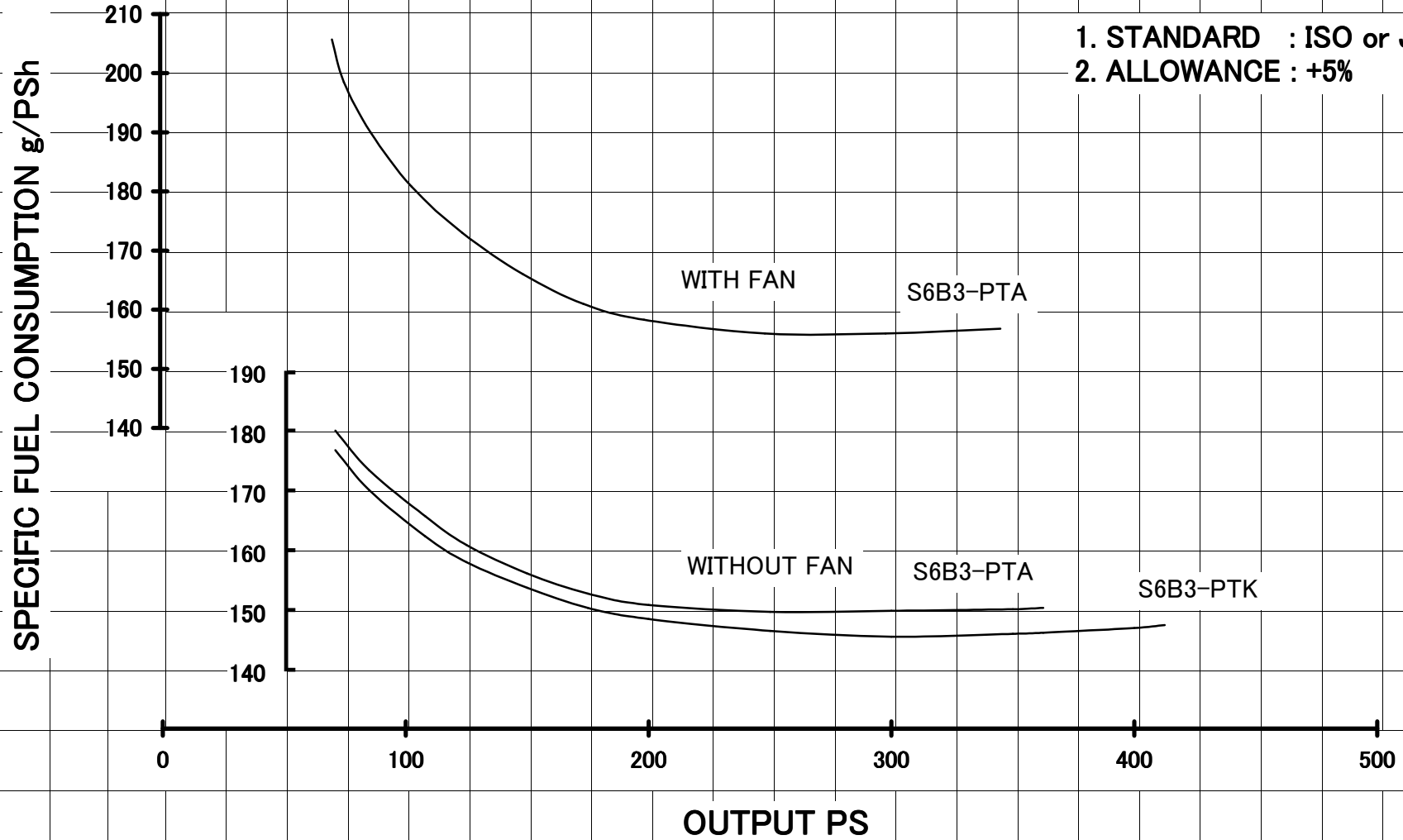

SPECIFIC FUEL CONSUMPTION

MODEL : S6B3 1500rpm

1. STANDARD : ISO or JIS

2. ALLOWANCE : +5%

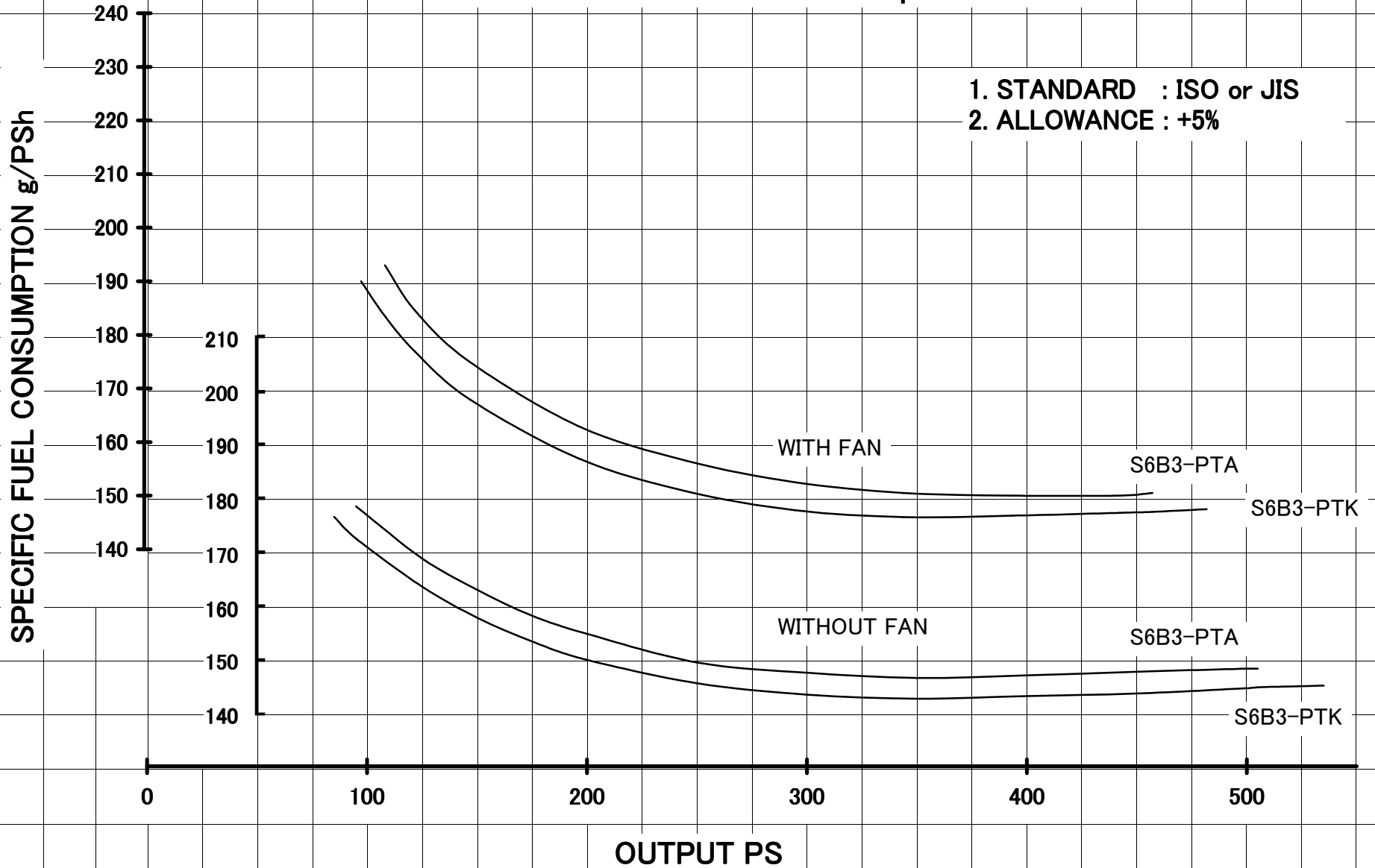

SPECIFIC FUEL CONSUMPTION MODEL : S6B3 1800rpm

- 1. STANDARD : ISO or JIS
- 2. ALLOWANCE : +5%

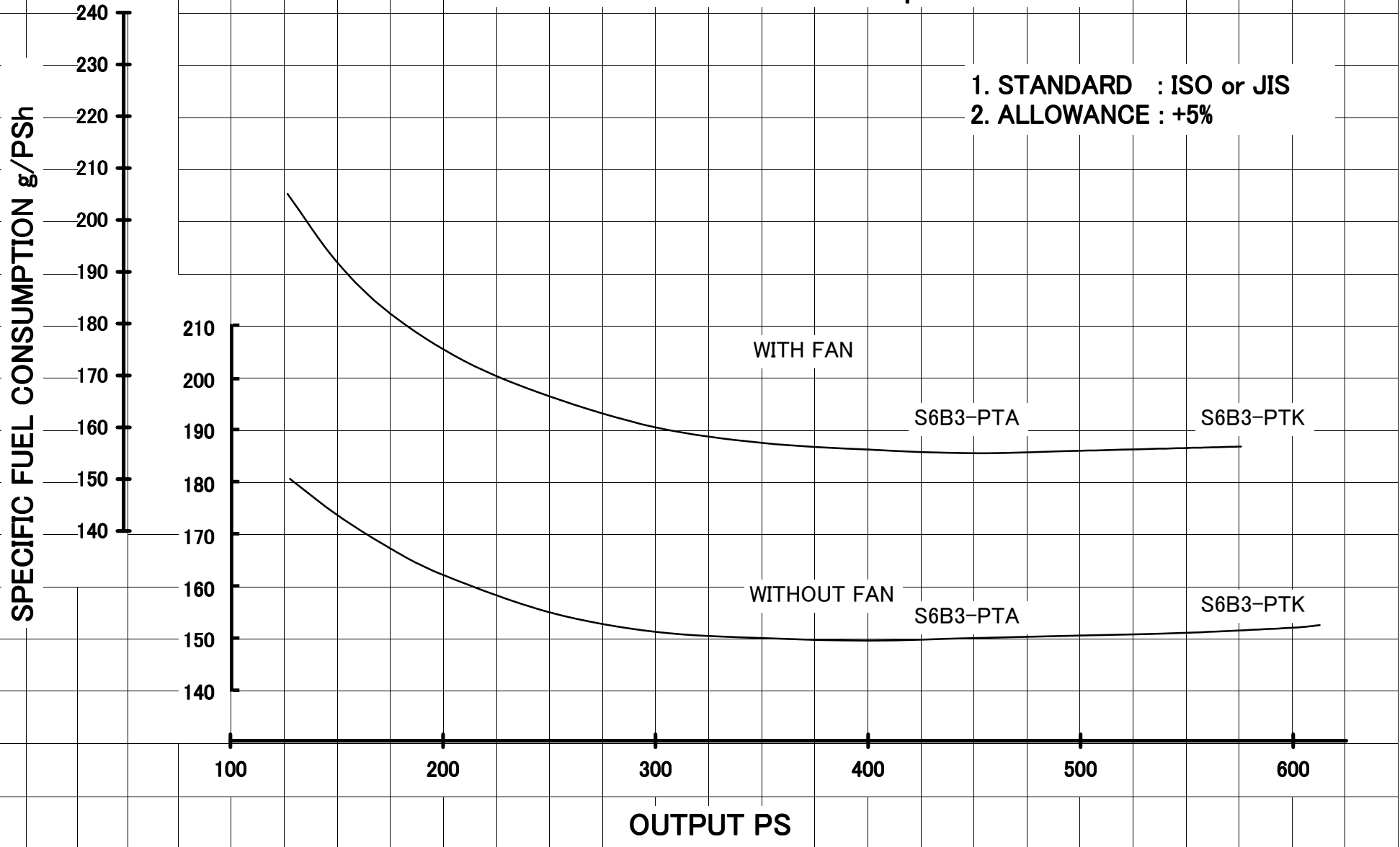

SPECIFIC FUEL CONSUMPTION

MODEL : S6A3 1200rpm

- 1. STANDARD : ISO or JIS
- 2. ALLOWANCE : +5%

SPECIFIC FUEL CONSUMPTION g/PS_h

210
200
190
180
170
160
150
140

190
180
170
160
150
140

WITH FAN

WITHOUT FAN

S6BA3-PTA

S6A3-PTK

0 100 200 300 400 500

OUTPUT PS

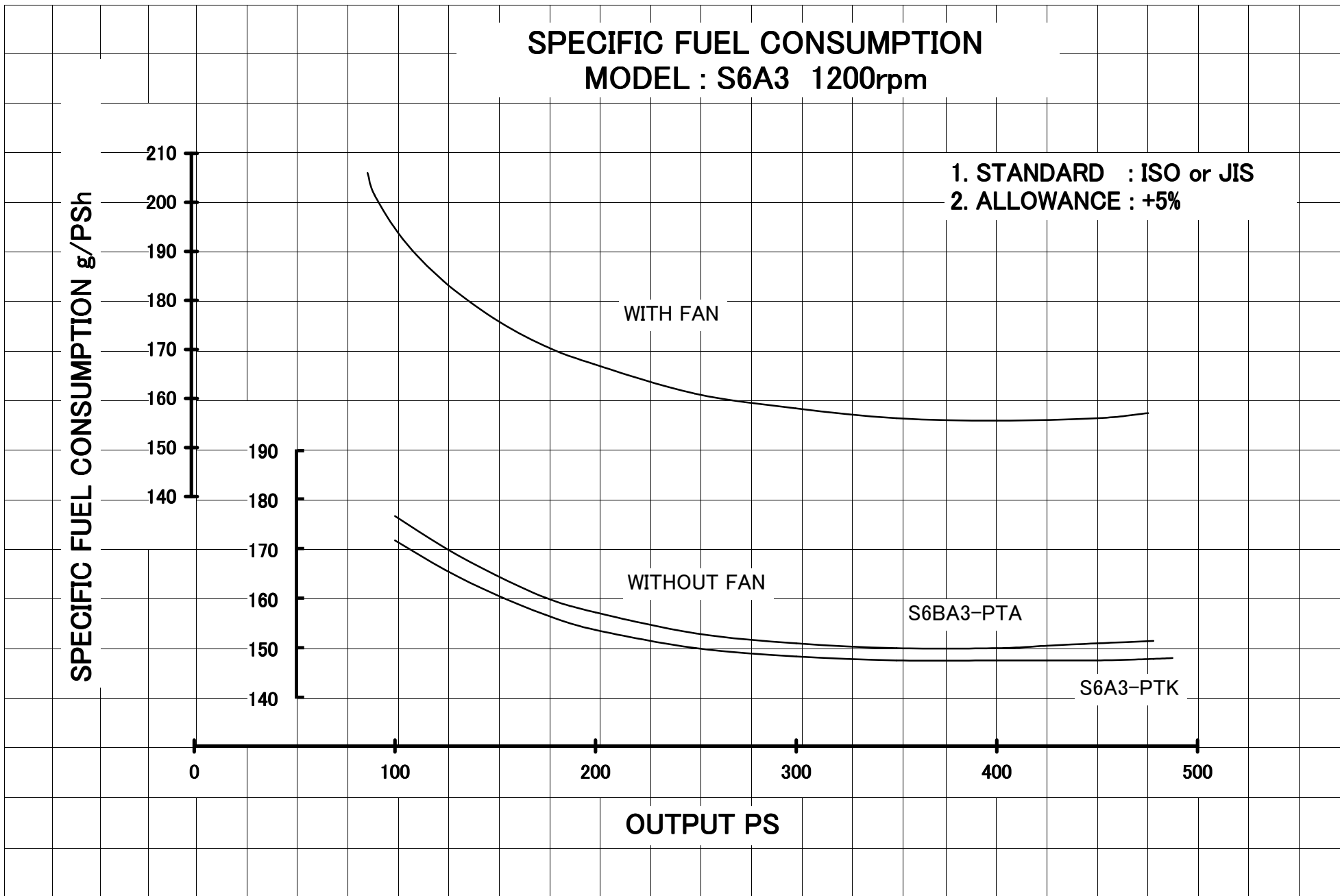

SPECIFIC FUEL CONSUMPTION

MODEL : S6A3 1500rpm

- 1. STANDARD : ISO or JIS
- 2. ALLOWANCE : +5%

SPECIFIC FUEL CONSUMPTION g/PSH

220
210
200
190
180
170
160
150
140

210
200
190
180
170
160
150
140

WITH FAN

S6A3-PTA

S6A3-PTK

WITHOUT FAN

S6A3-PTA

S6A3-PTK

0 100 200 300 400 500 600 700

OUTPUT PS

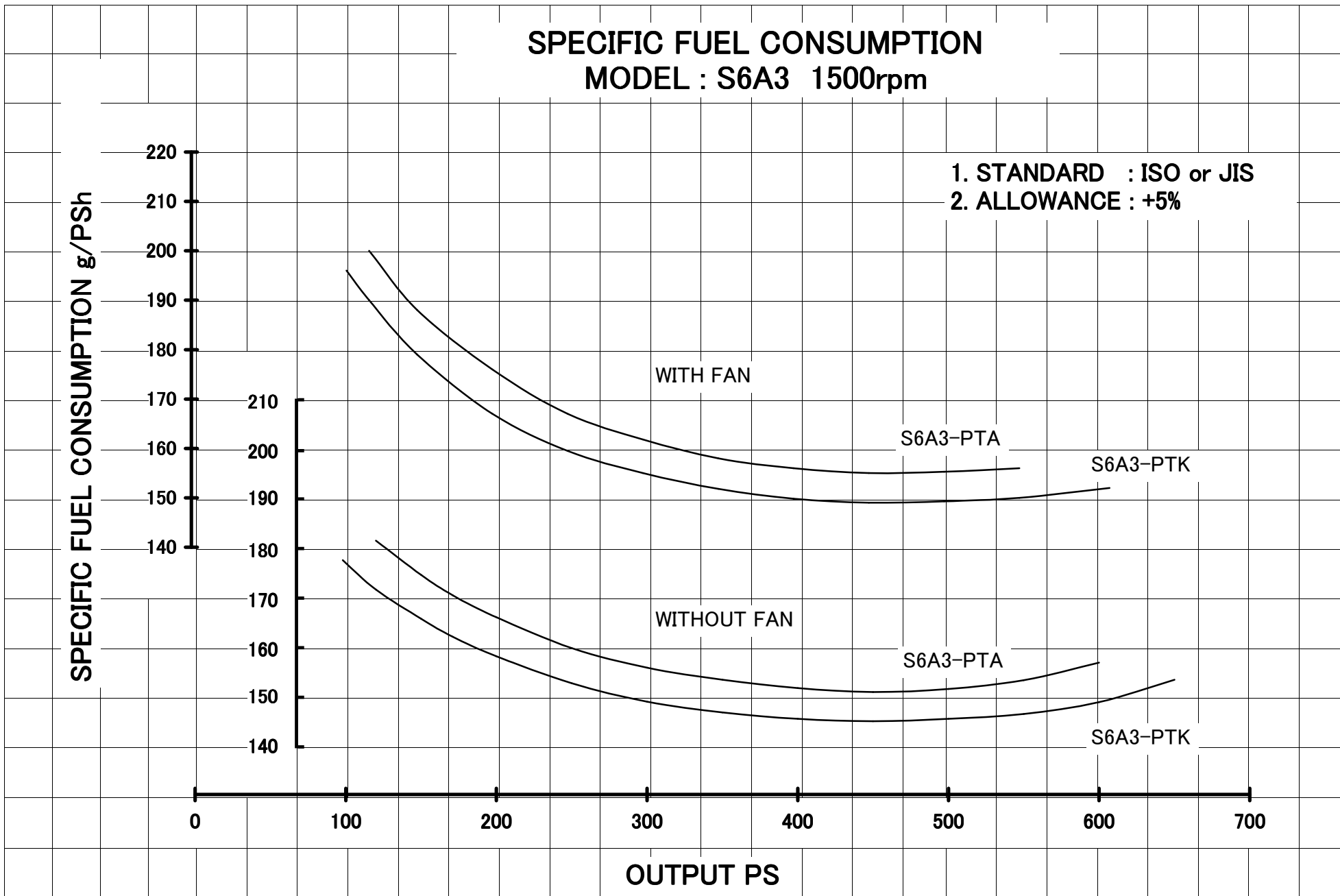

SPECIFIC FUEL CONSUMPTION

MODEL : S6A3 1800rpm

- 1. STANDARD : ISO or JIS
- 2. ALLOWANCE : +5%

SPECIFIC FUEL CONSUMPTION g/PS_h

230
220
210
200
190
180
170
160
150

210
200
190
180
170
160
150

WITH FAN

S6A3-PTA

S6A3-PTK

WITHOUT FAN

S6A3-PTA

S6A3-PTK

0

100

200

300

400

500

600

700

OUTPUT PS

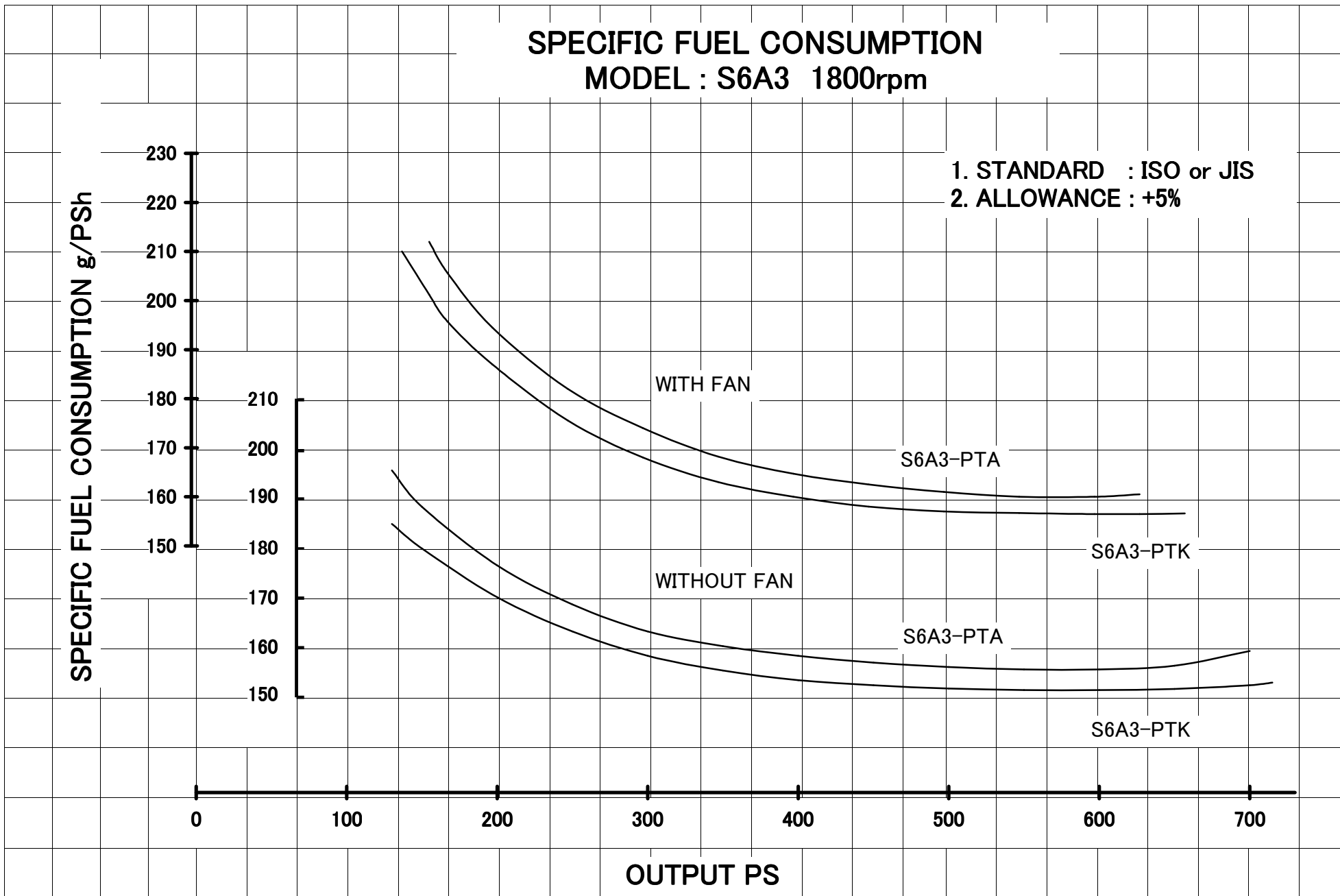

SPECIFIC FUEL CONSUMPTION MODEL : S12A2 1200rpm

- 1. STANDARD : ISO or JIS
- 2. ALLOWANCE : +5%

SPECIFIC FUEL CONSUMPTION g/PS_h

190
180
170
160
150

180
170
160
150

0

200

400

600

800

OUTPUT PS

WITH FAN

S12A2-PT

S12A2-PTA

S12A2-PTK

WITHOUT FAN

S12A2-PT

S12A2-PTA

S12A2-PTK

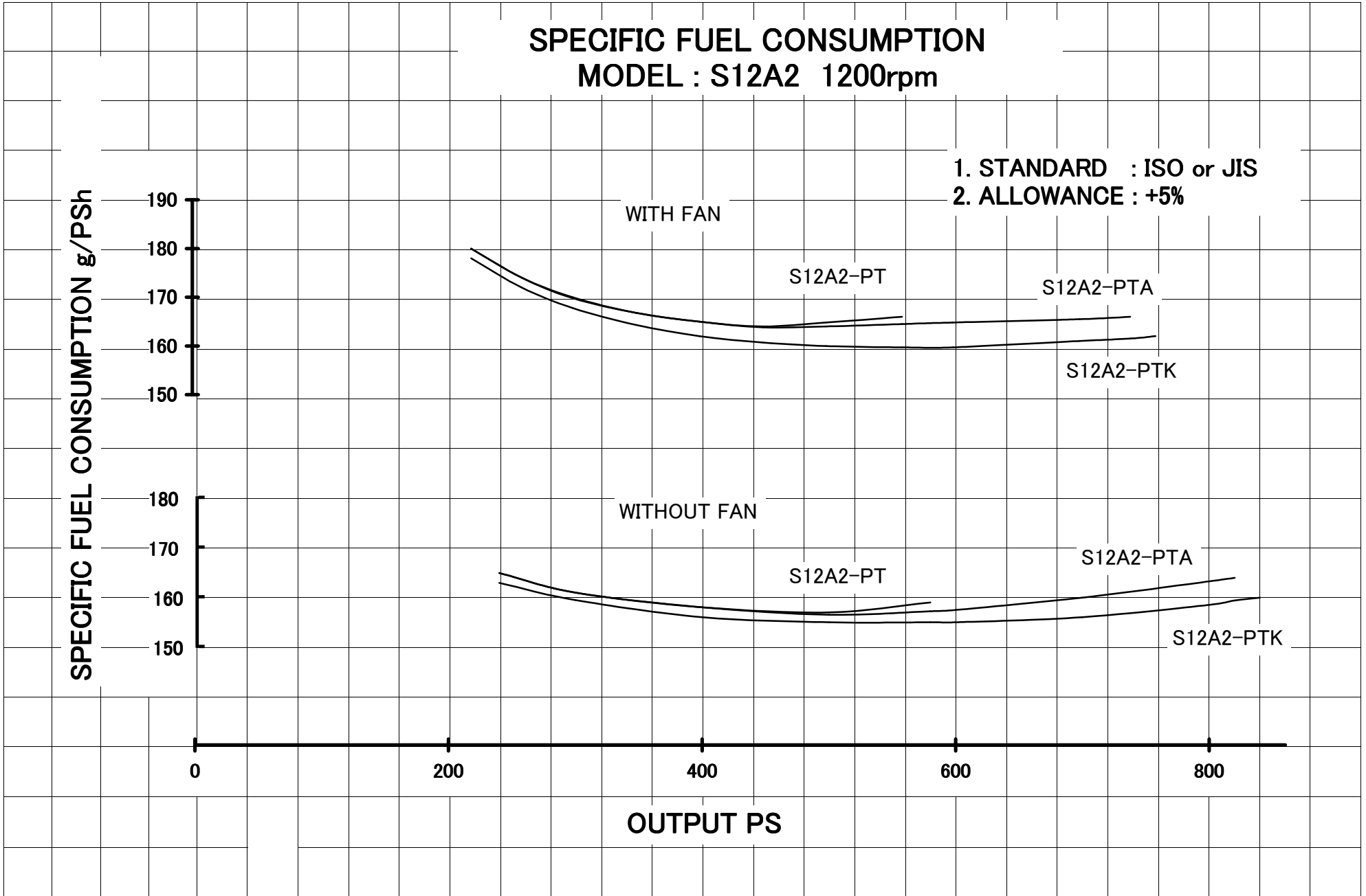

SPECIFIC FUEL CONSUMPTION MODEL : S12A2 1500rpm

- 1. STANDARD : ISO or JIS
- 2. ALLOWANCE : +5%

SPECIFIC FUEL CONSUMPTION g/PS_h

190
180
170
160
150

190
180
170
160
150
140

0

200

400

600

800

1000

OUTPUT PS

WITH FAN

S12A2-PT

S12A2-PTA

S12A2-PTK

WITHOUT FAN

S12A2-PT

S12A2-PTA

S12A2-PTK

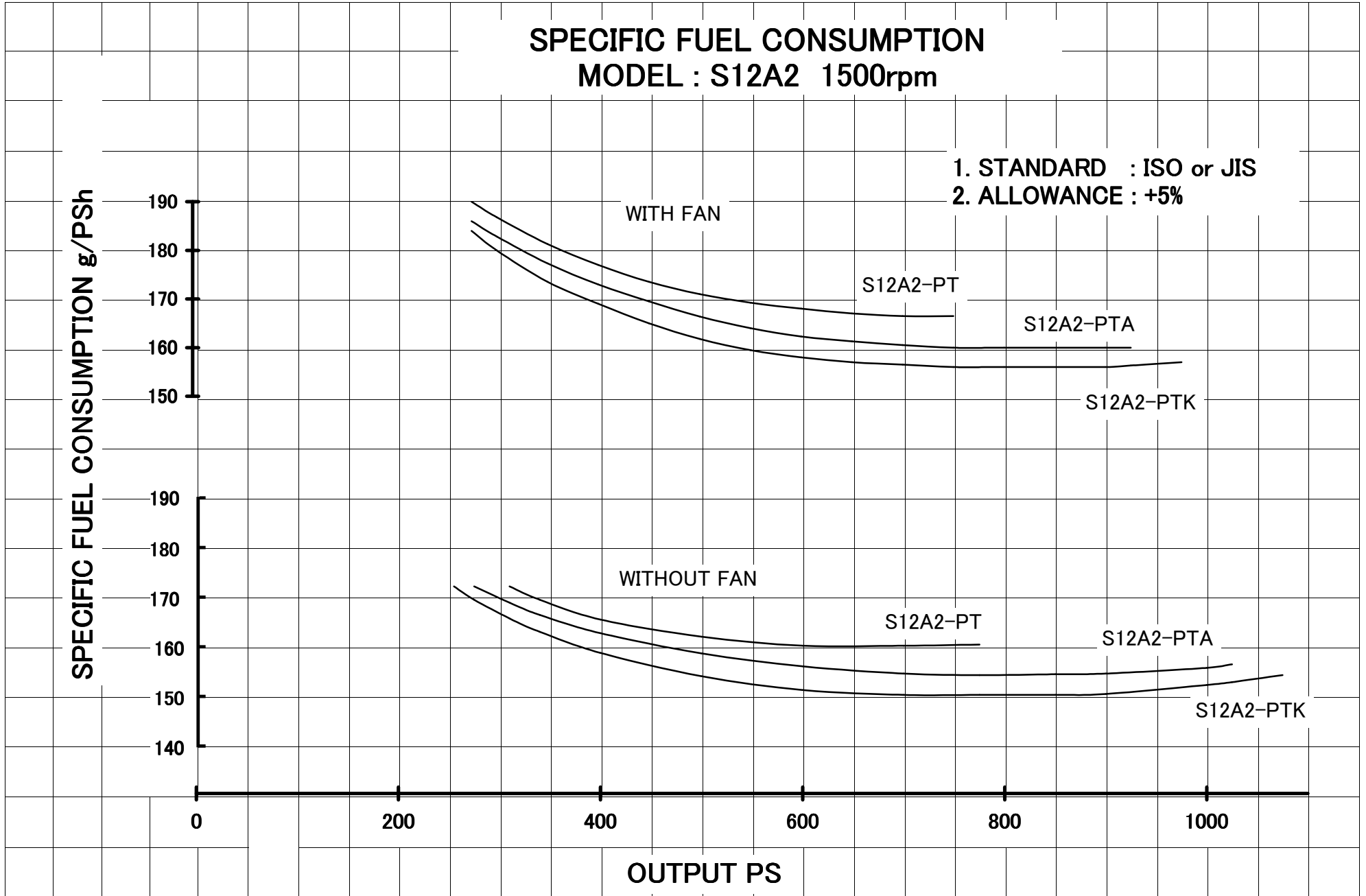

SPECIFIC FUEL CONSUMPTION MODEL : S12A2 1800rpm

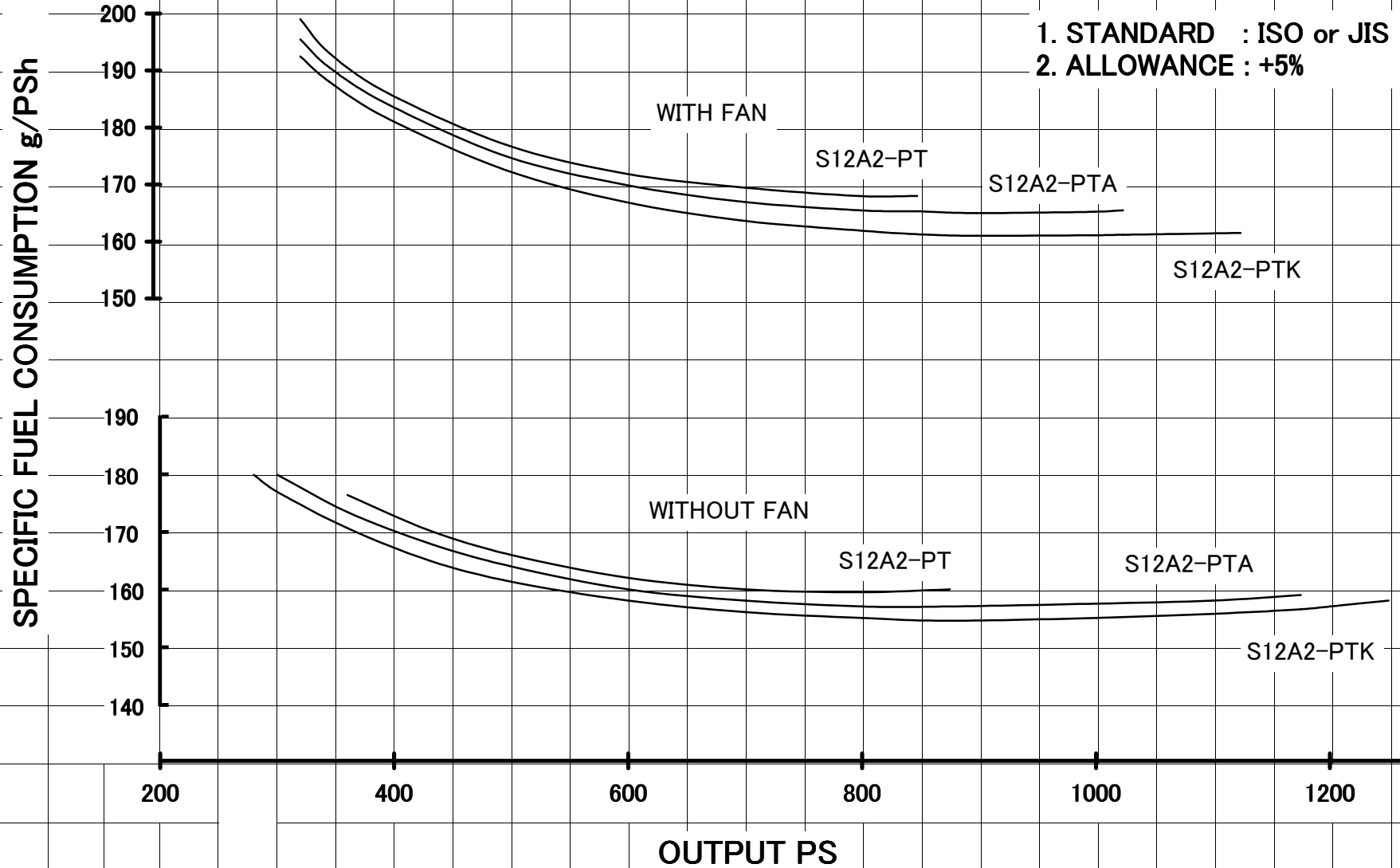

SPECIFIC FUEL CONSUMPTION MODEL : S6R 1200rpm

- 1. STANDARD : ISO or JIS
- 2. ALLOWANCE : +5%

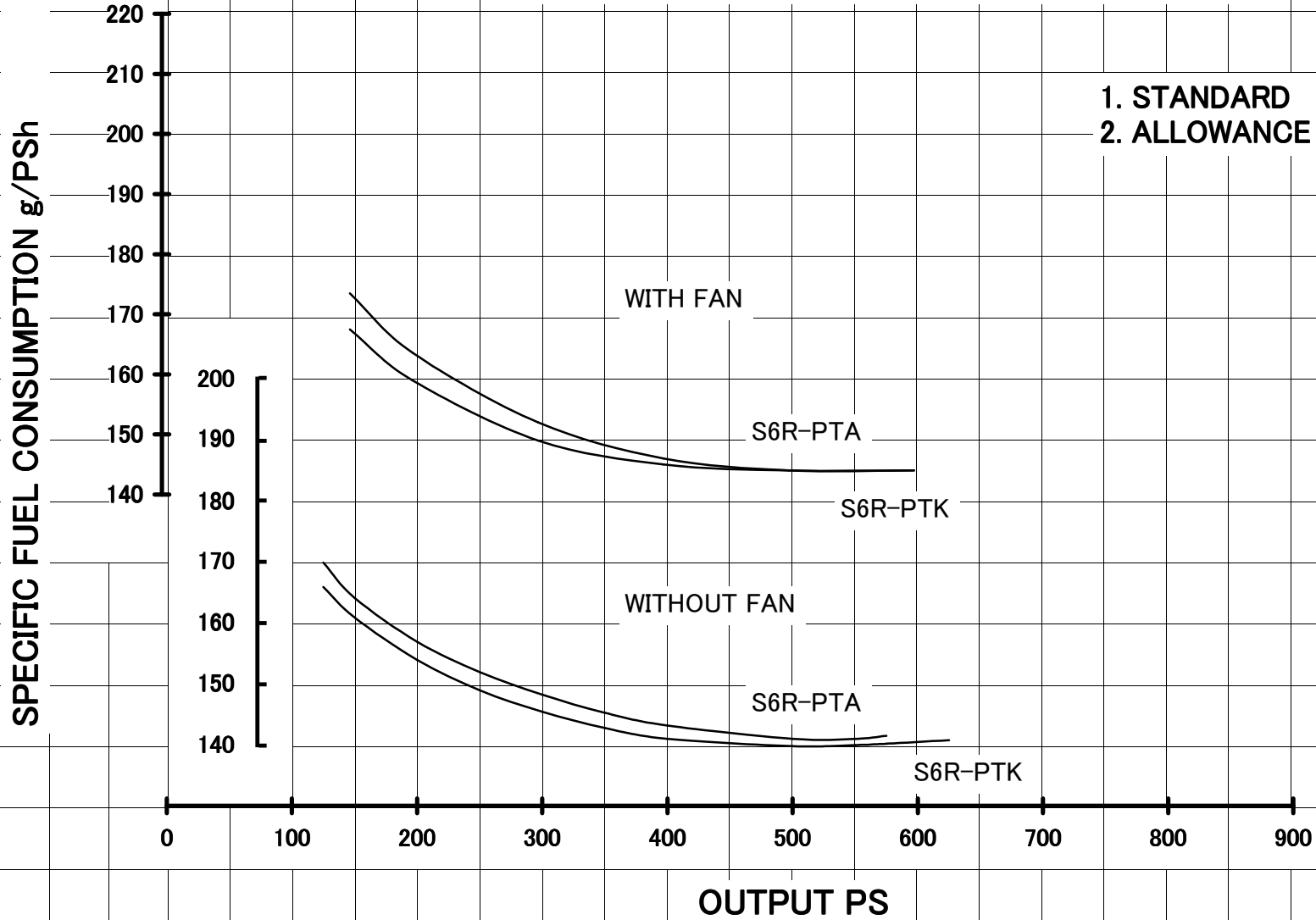

SPECIFIC FUEL CONSUMPTION

MODEL : S6R 1500rpm

1. STANDARD : ISO or JIS

2. ALLOWANCE : +5%

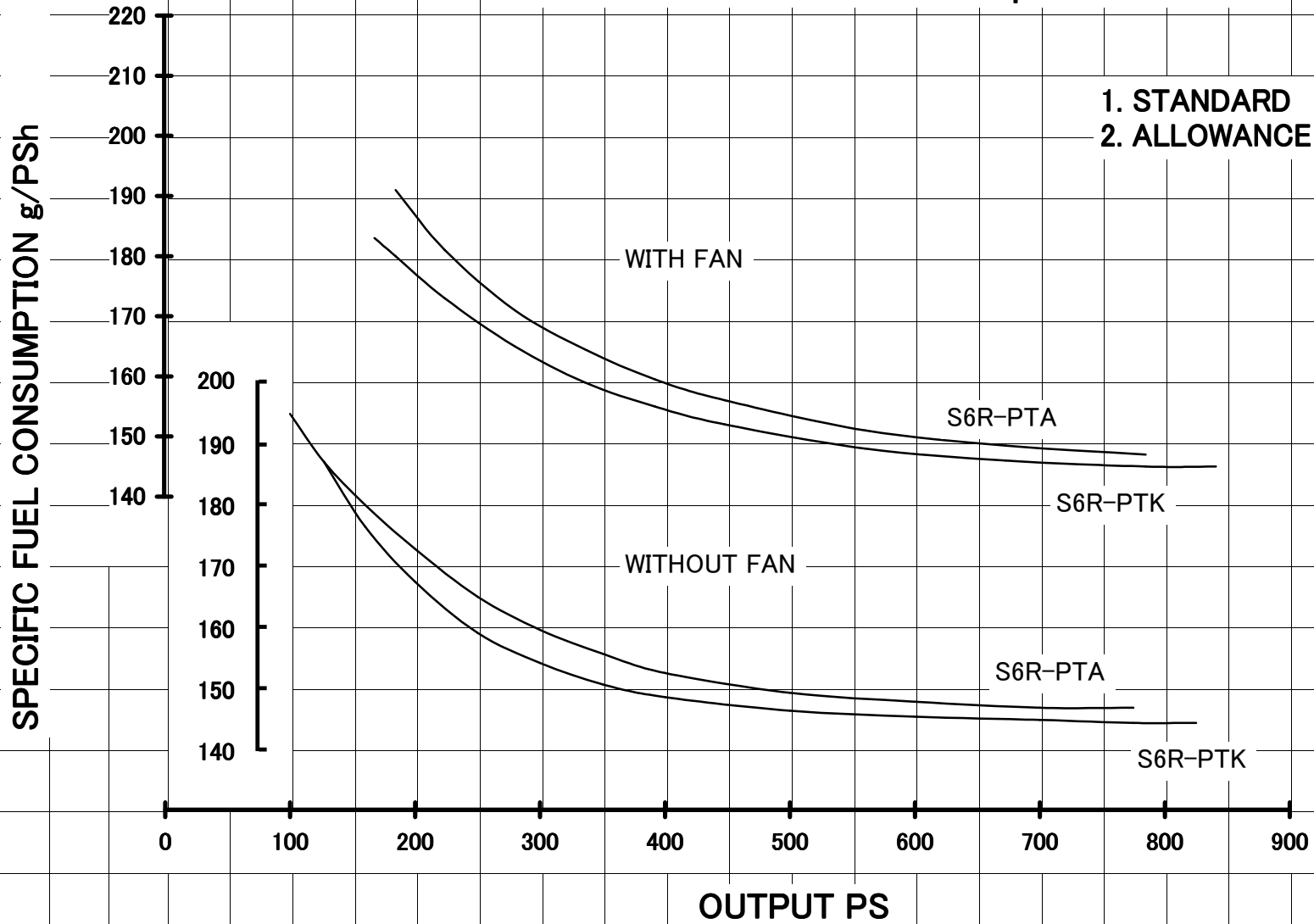

SPECIFIC FUEL CONSUMPTION MODEL : S6R 1800rpm

- 1. STANDARD : ISO or JIS
- 2. ALLOWANCE : +5%

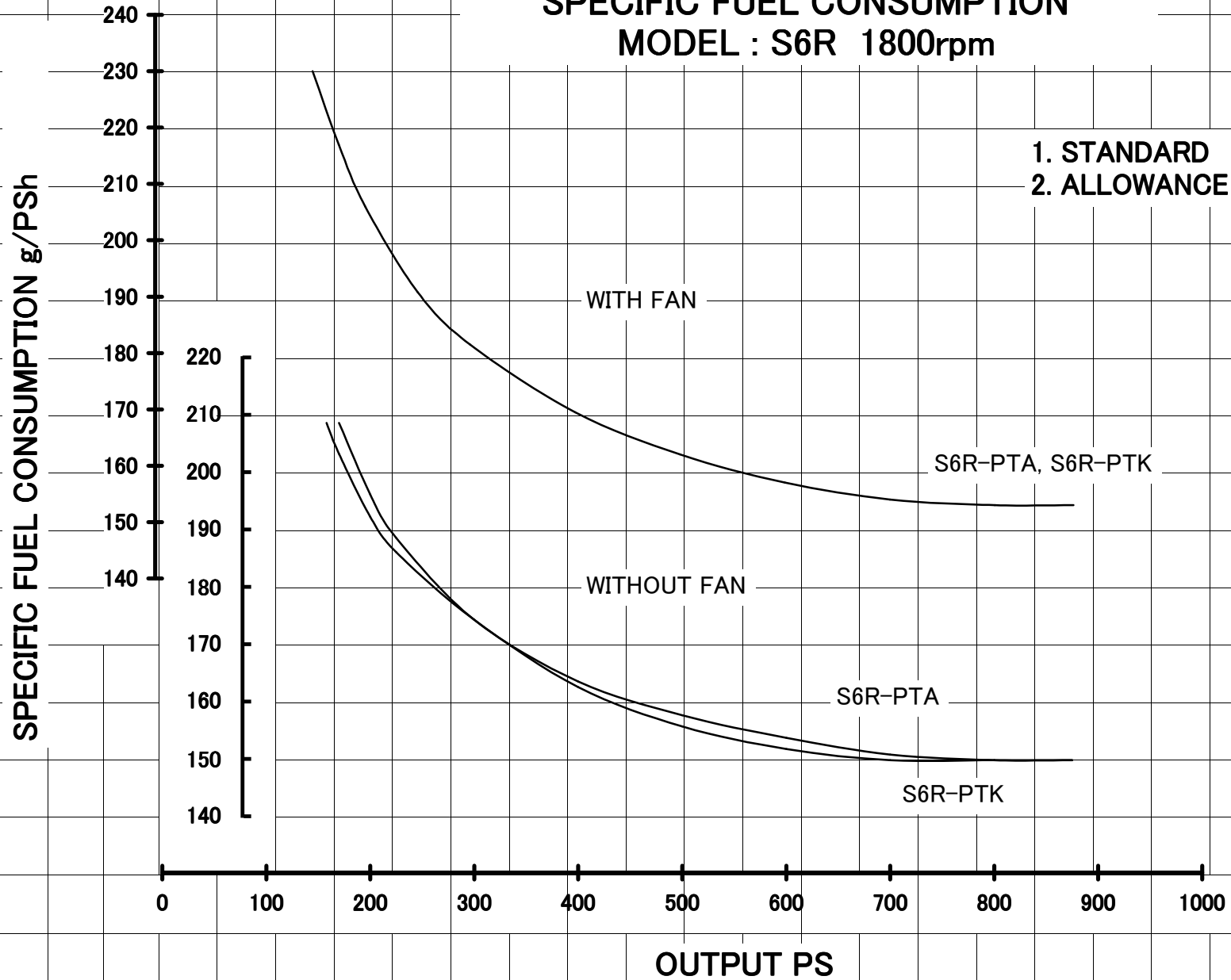

SPECIFIC FUEL CONSUMPTION MODEL : S6R2 1000rpm

- 1. STANDARD : ISO or JIS
- 2. ALLOWANCE : +5%

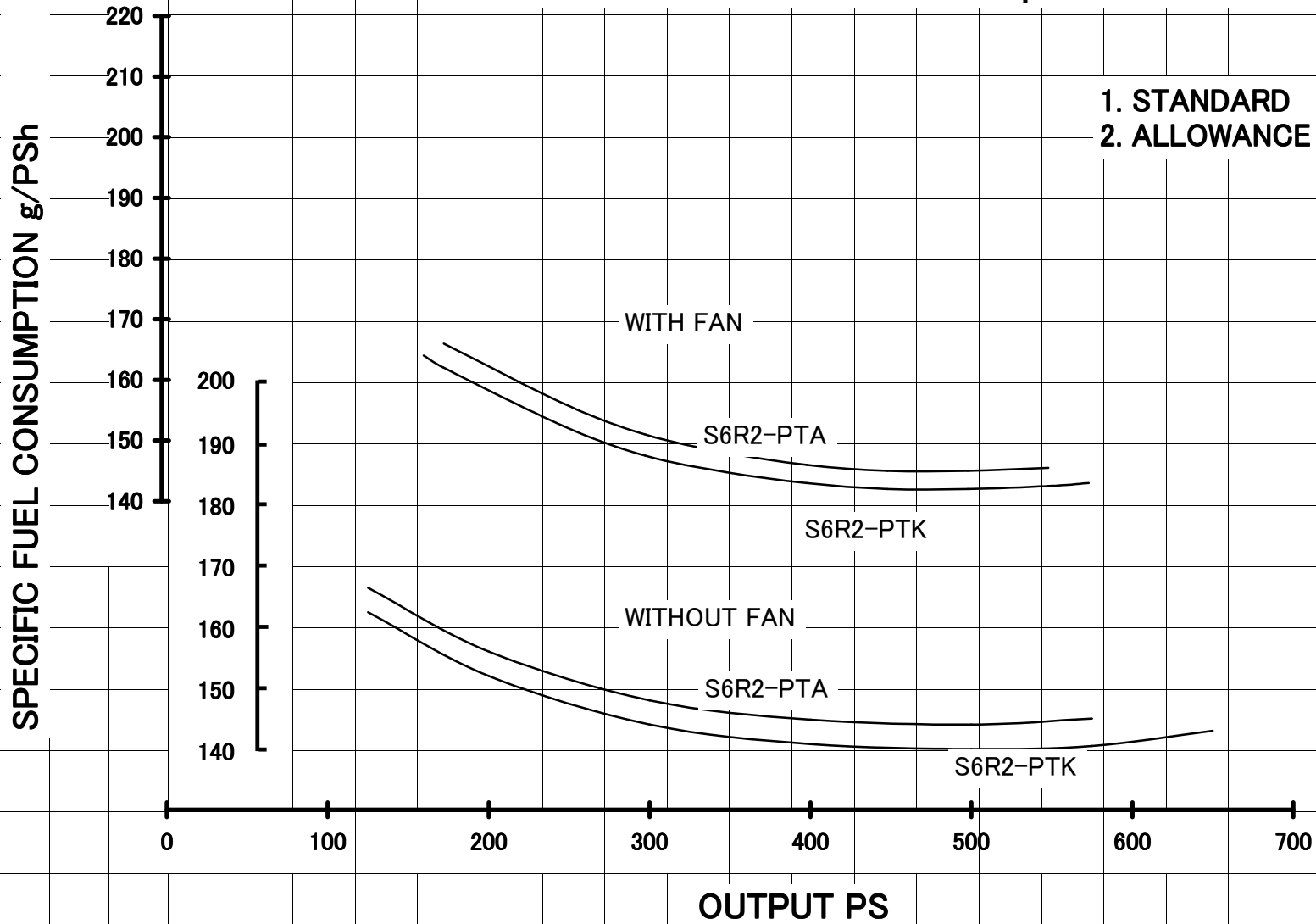

SPECIFIC FUEL CONSUMPTION

MODEL : S6R2 1200rpm

1. STANDARD : ISO or JIS

2. ALLOWANCE : +5%

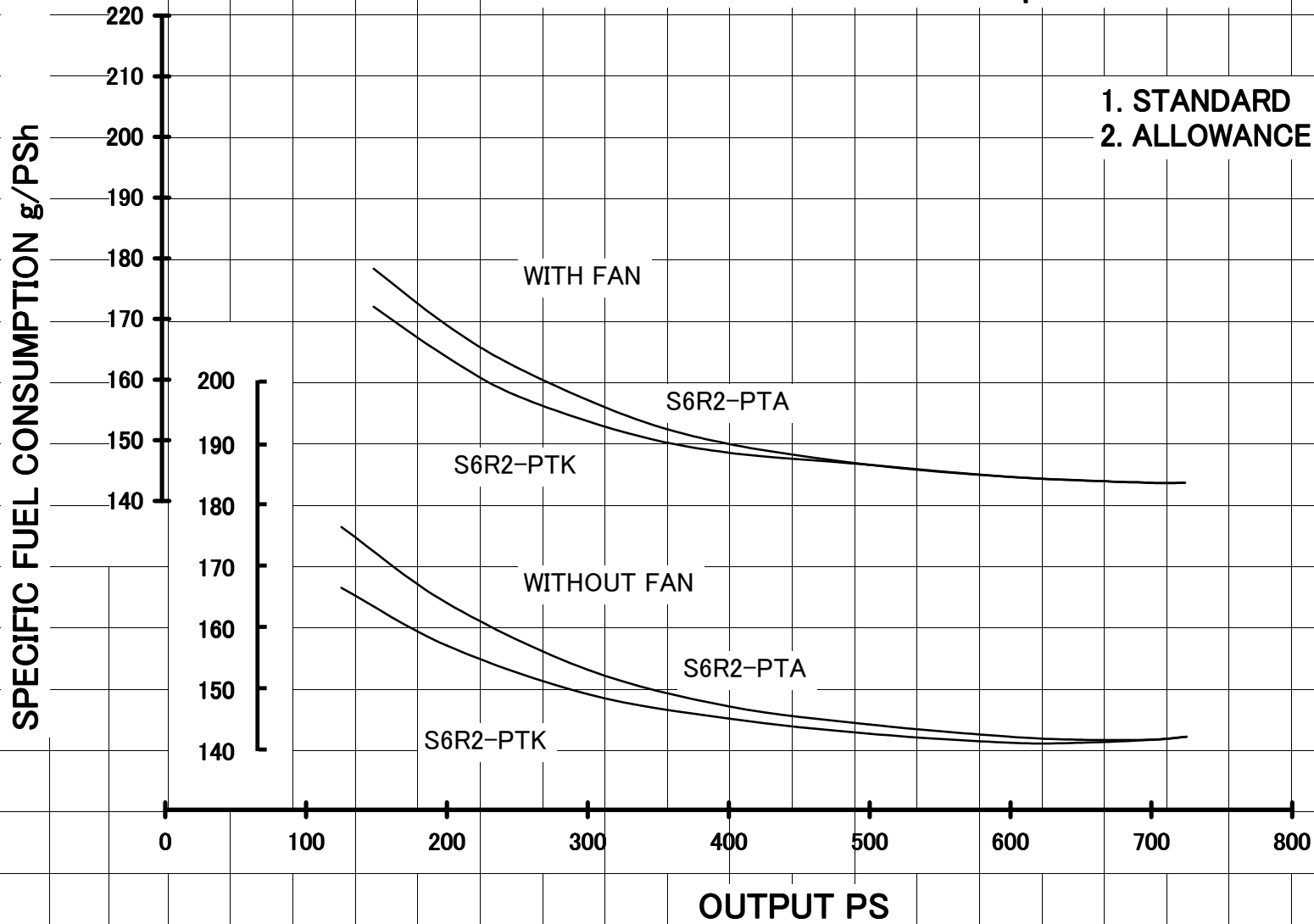

SPECIFIC FUEL CONSUMPTION MODEL : S6R2 1500rpm

- 1. STANDARD : ISO or JIS
- 2. ALLOWANCE : +5%

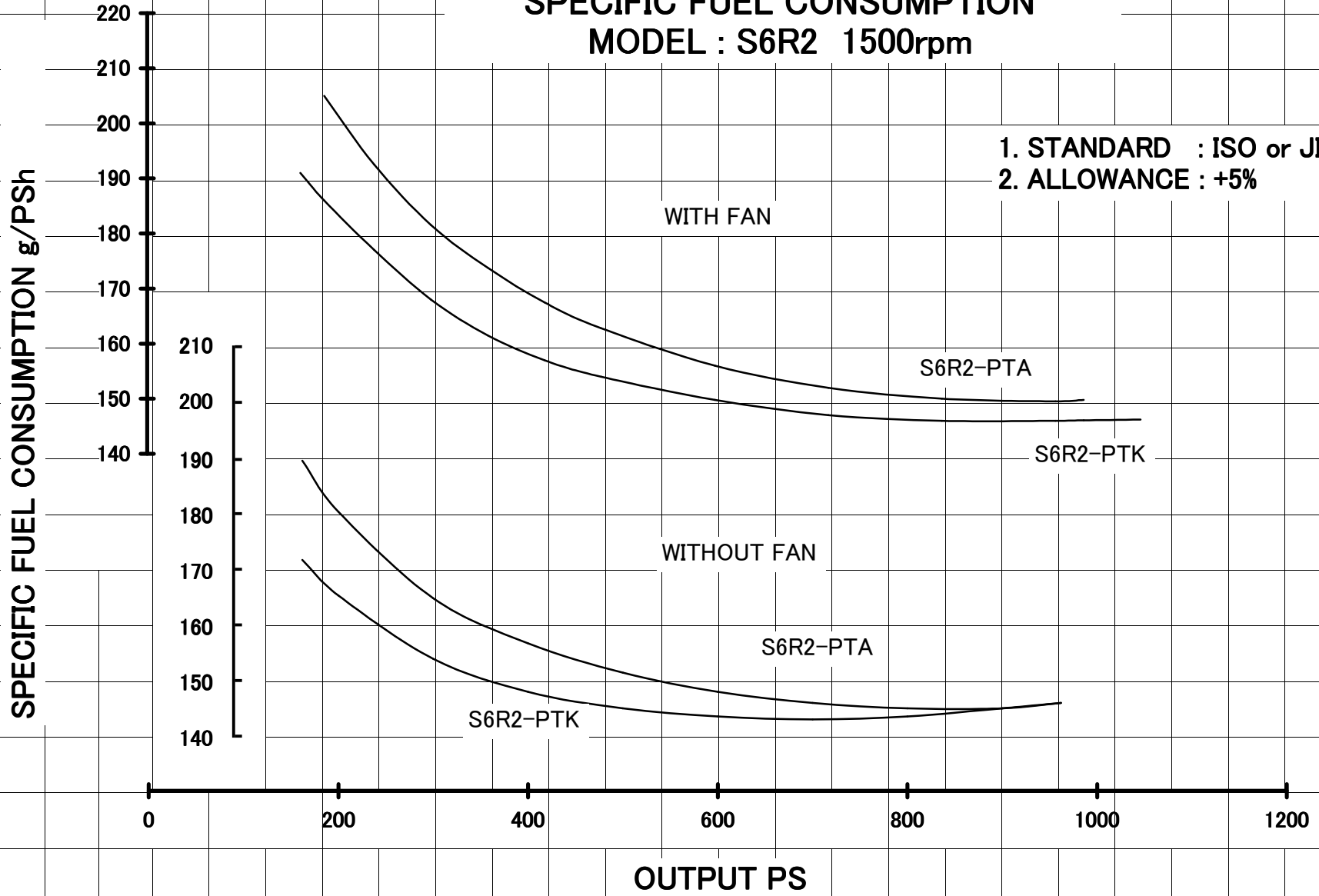

SPECIFIC FUEL CONSUMPTION MODEL : S12R 1200rpm

- 1. STANDARD : ISO or JIS
- 2. ALLOWANCE : +5%

SPECIFIC FUEL CONSUMPTION g/PS_h

200
190
180
170
160
150
140
190
180
170
160
150
140

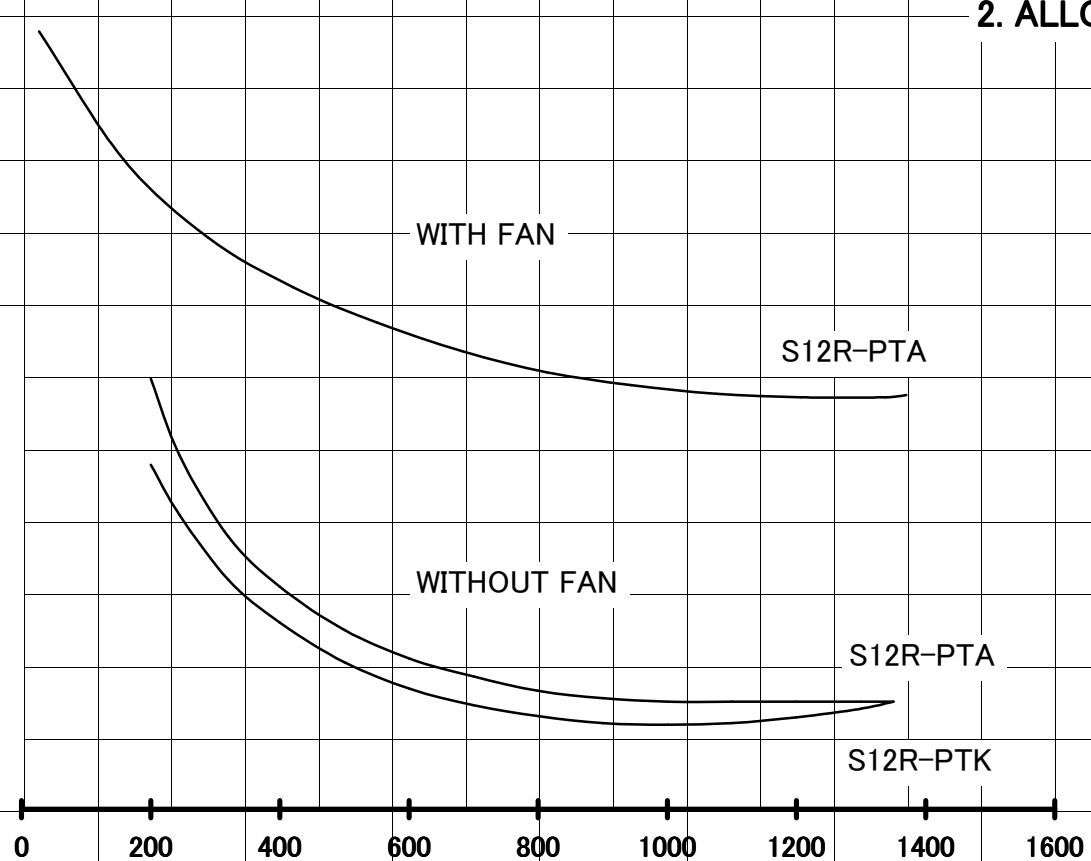

OUTPUT PS

SPECIFIC FUEL CONSUMPTION MODEL : S12R 1500rpm

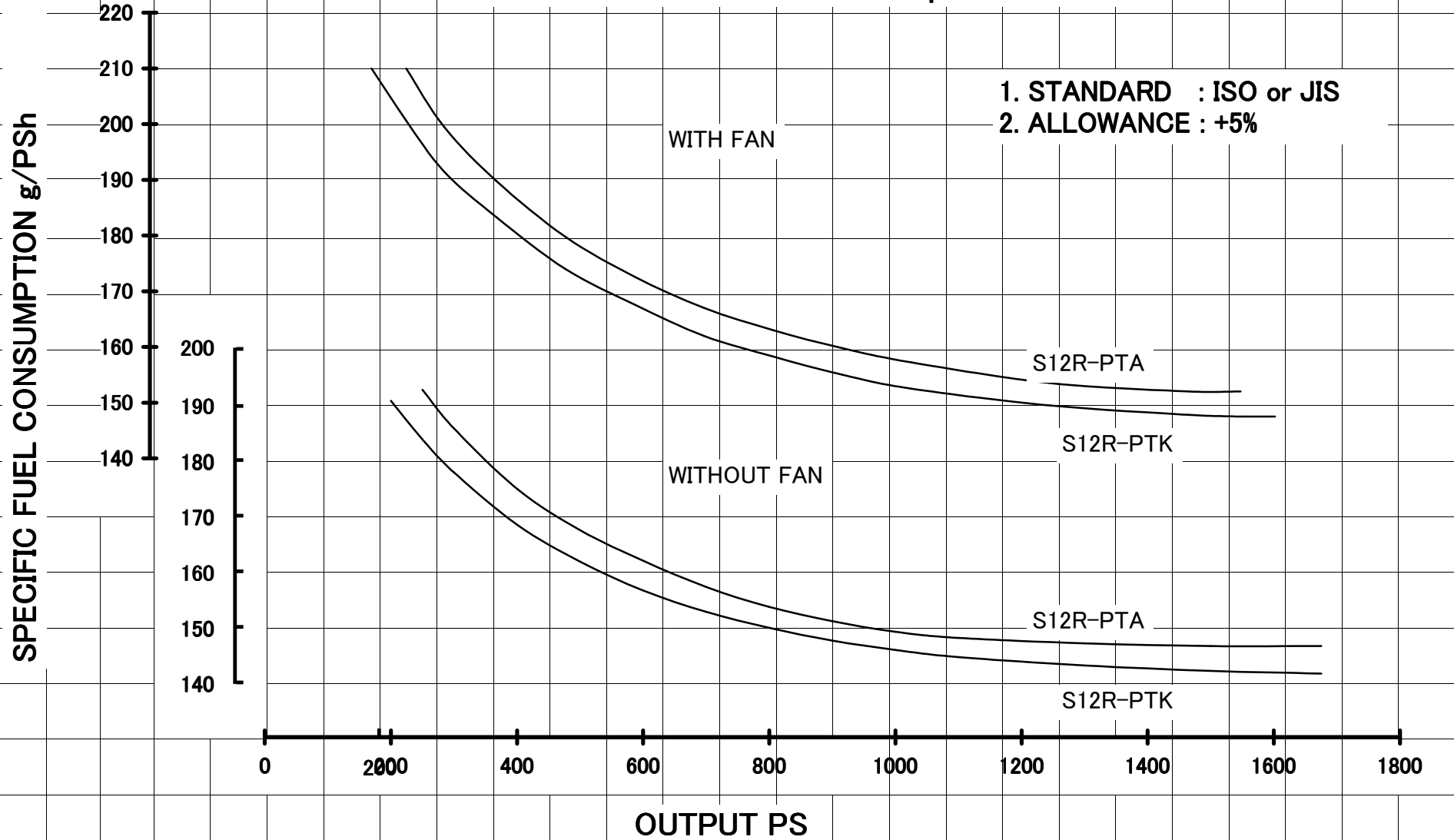

SPECIFIC FUEL CONSUMPTION MODEL : S12R 1800rpm

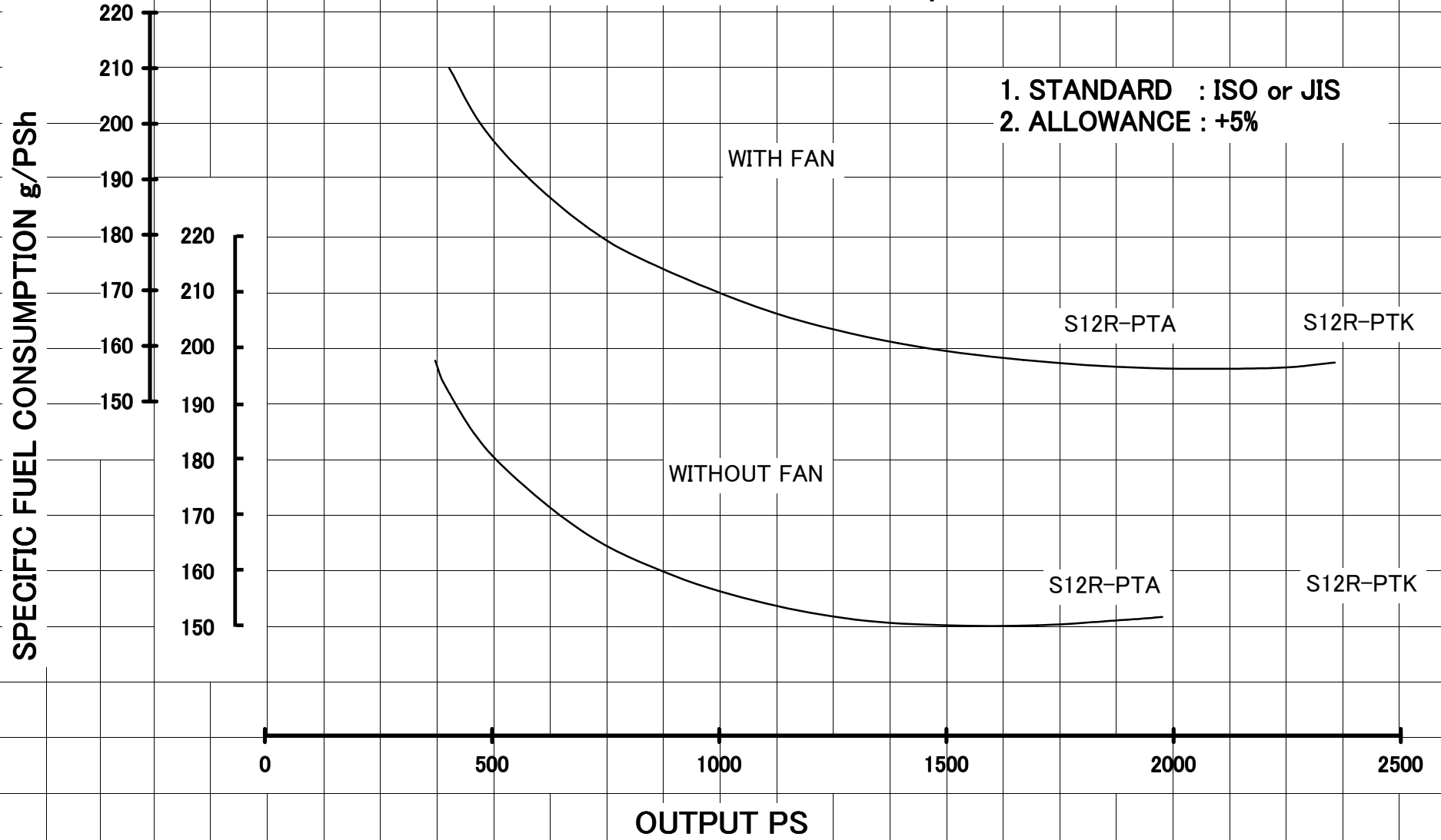

SPECIFIC FUEL CONSUMPTION MODEL : S16R 1200rpm

- 1. STANDARD : ISO or JIS
- 2. ALLOWANCE : +5%

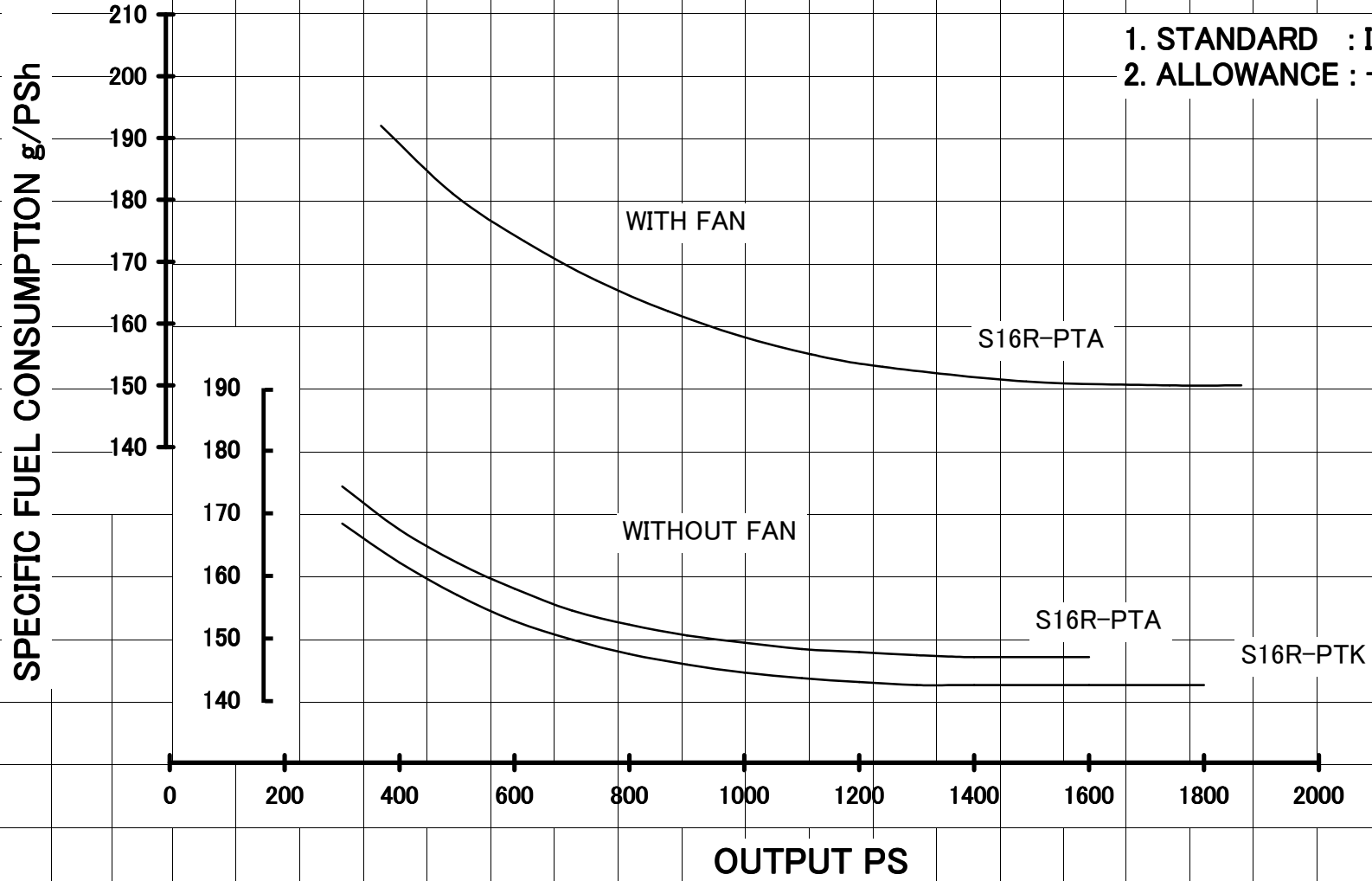

SPECIFIC FUEL CONSUMPTION MODEL : S16R 1500rpm

- 1. STANDARD : ISO or JIS
- 2. ALLOWANCE : +5%

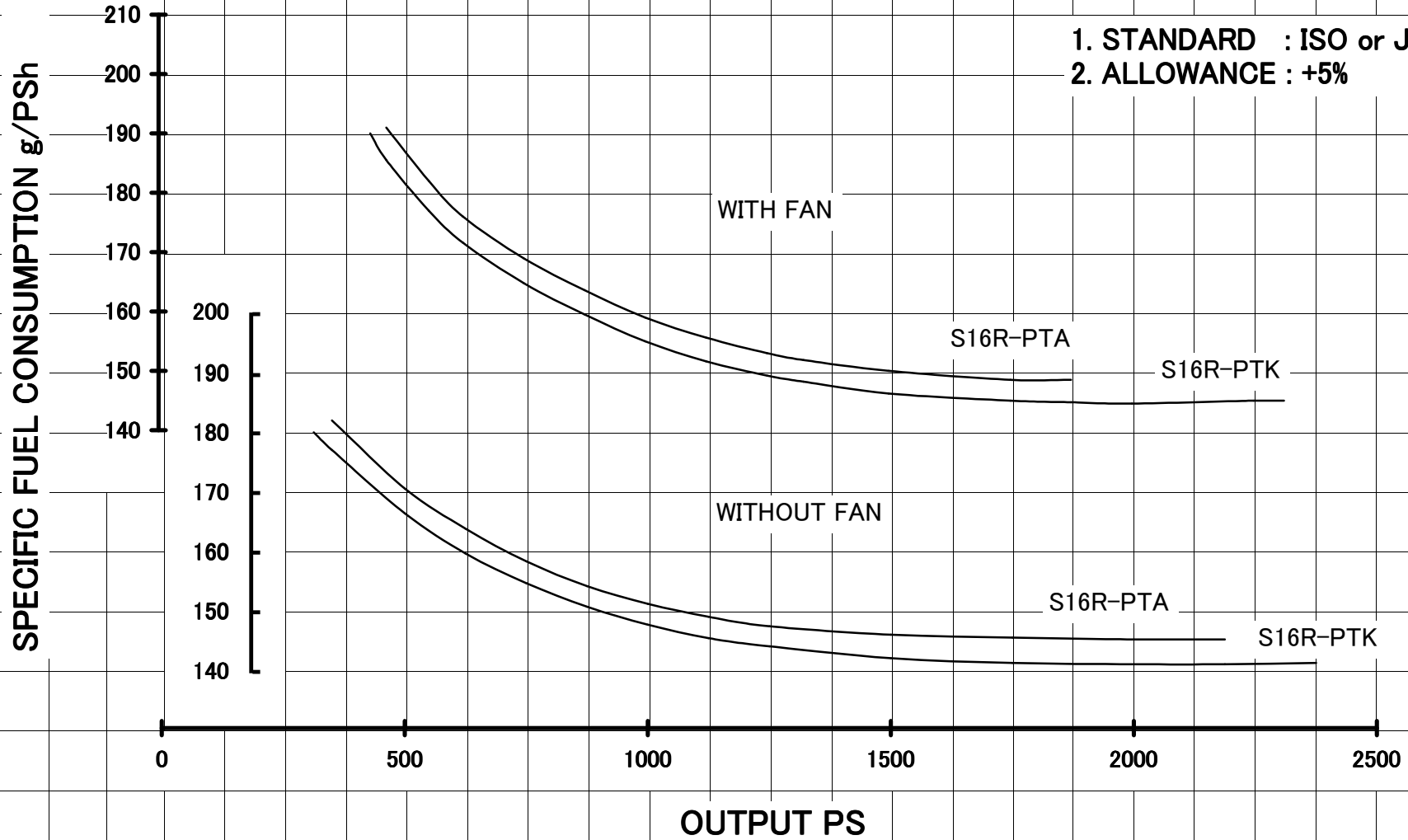

SPECIFIC FUEL CONSUMPTION MODEL : S16R 1800rpm

- 1. STANDARD : ISO or JIS
- 2. ALLOWANCE : +5%

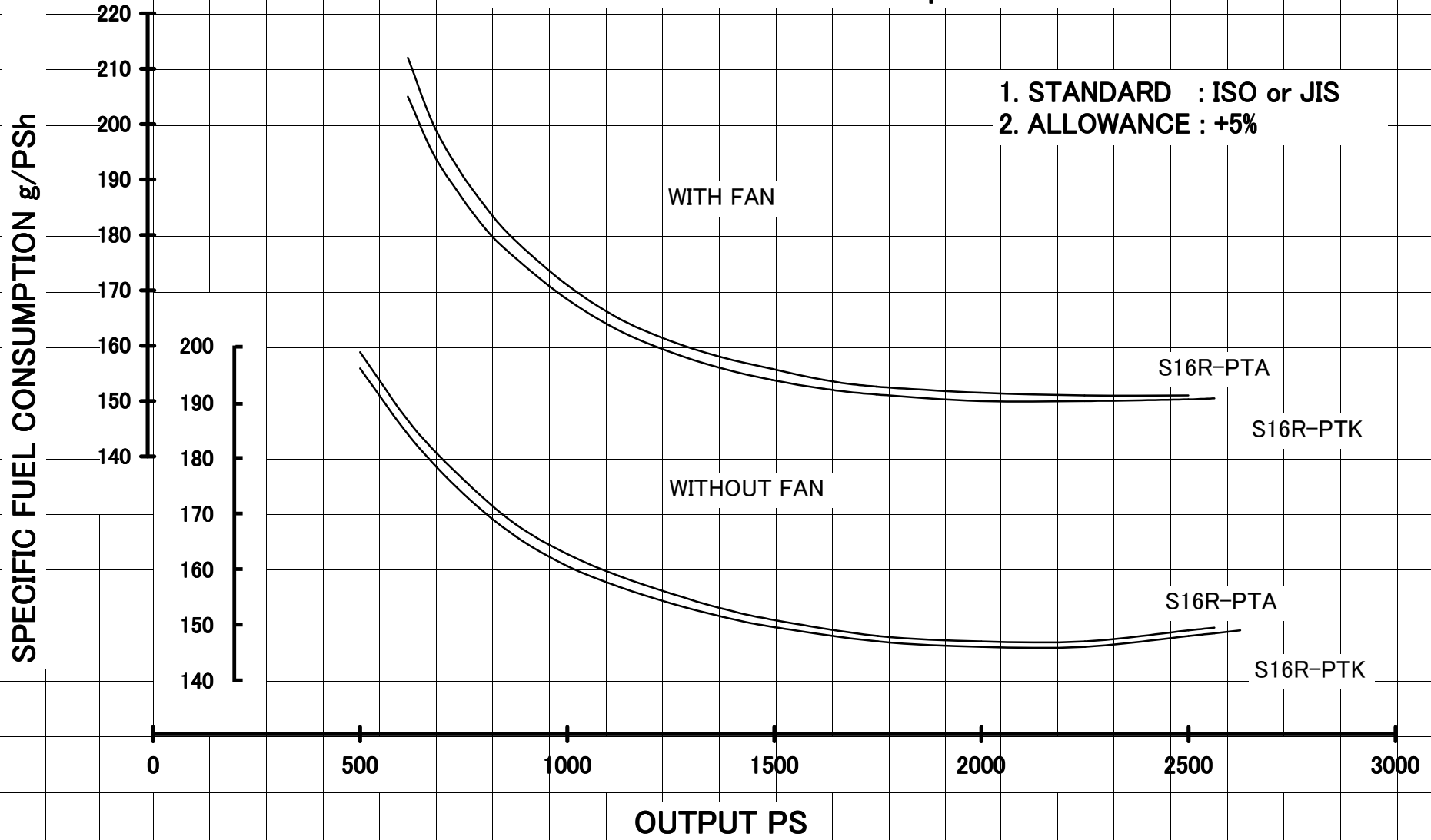

SPECIFIC FUEL CONSUMPTION MODEL : S16R-2 1500rpm

- 1. STANDARD : ISO or JIS
- 2. ALLOWANCE : +5%
- 3. THIS INFORMATION IS SUBJECT TO CHANGE WITHOUT NOTICE

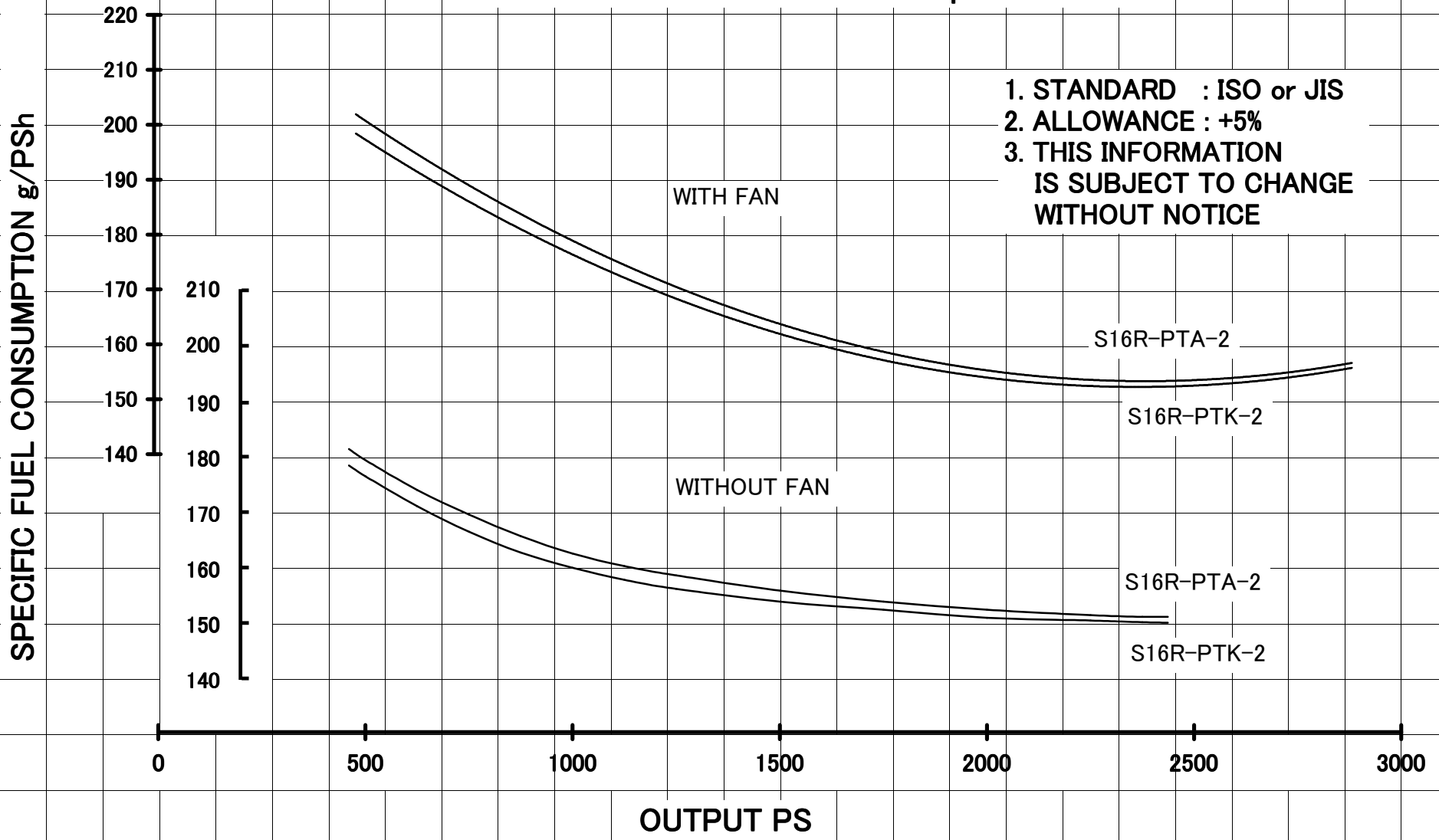

SPECIFIC FUEL CONSUMPTION

MODEL : S16R-2 1800rpm

1. STANDARD : ISO or JIS
2. ALLOWANCE : +5%
3. THIS INFORMATION IS SUBJECT TO CHANGE WITHOUT NOTICE

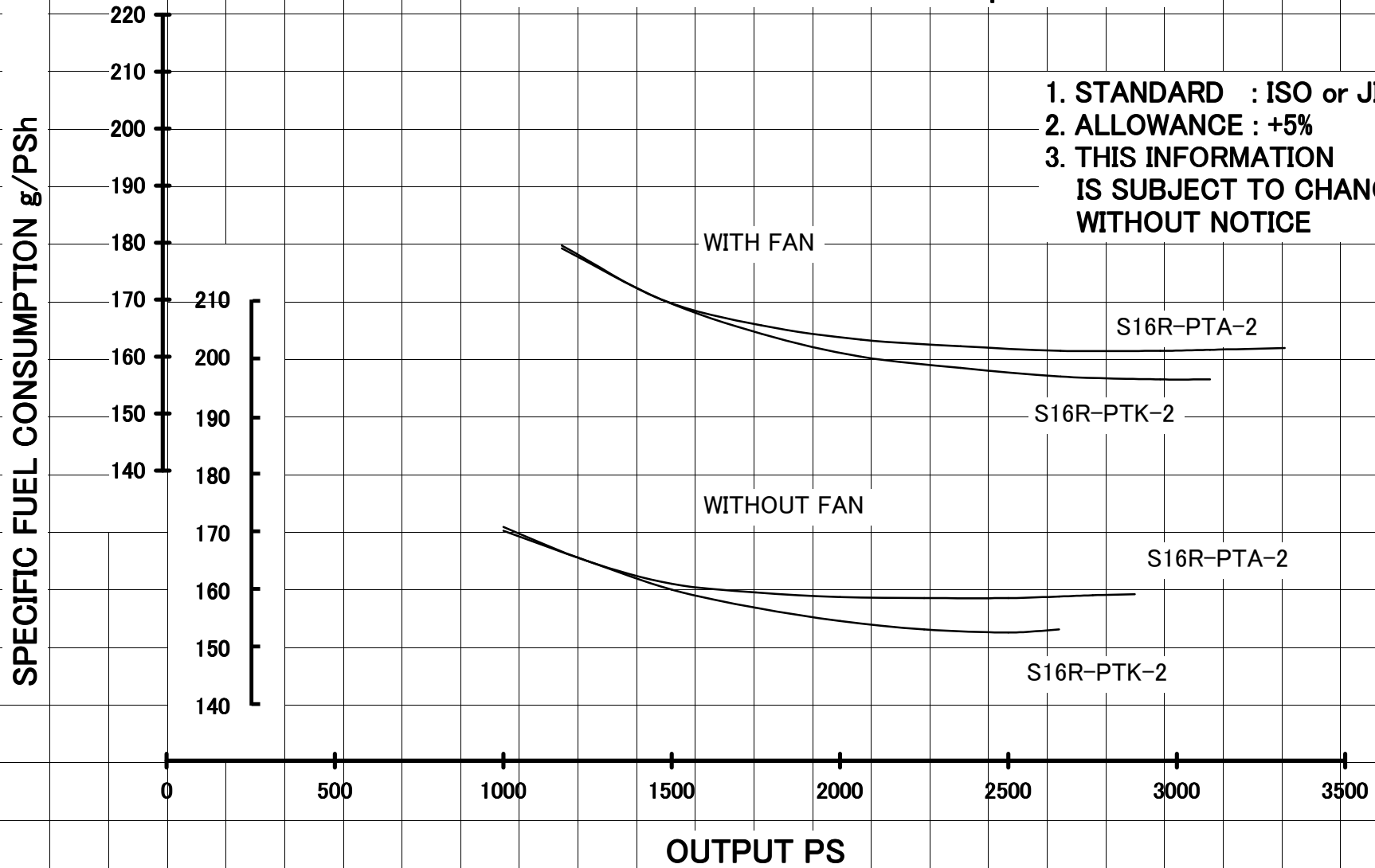

SPECIFIC FUEL CONSUMPTION
MODEL : S6R2-PTAA 1500rpm

- 1. STANDARD : ISO or JIS
- 2. ALLOWANCE : +5%

SPECIFIC FUEL CONSUMPTION g/PS_h

200
190
180
170
160
150
140

0 100 200 300 400 500 600 700 800 900 1000 1100

OUTPUT PS

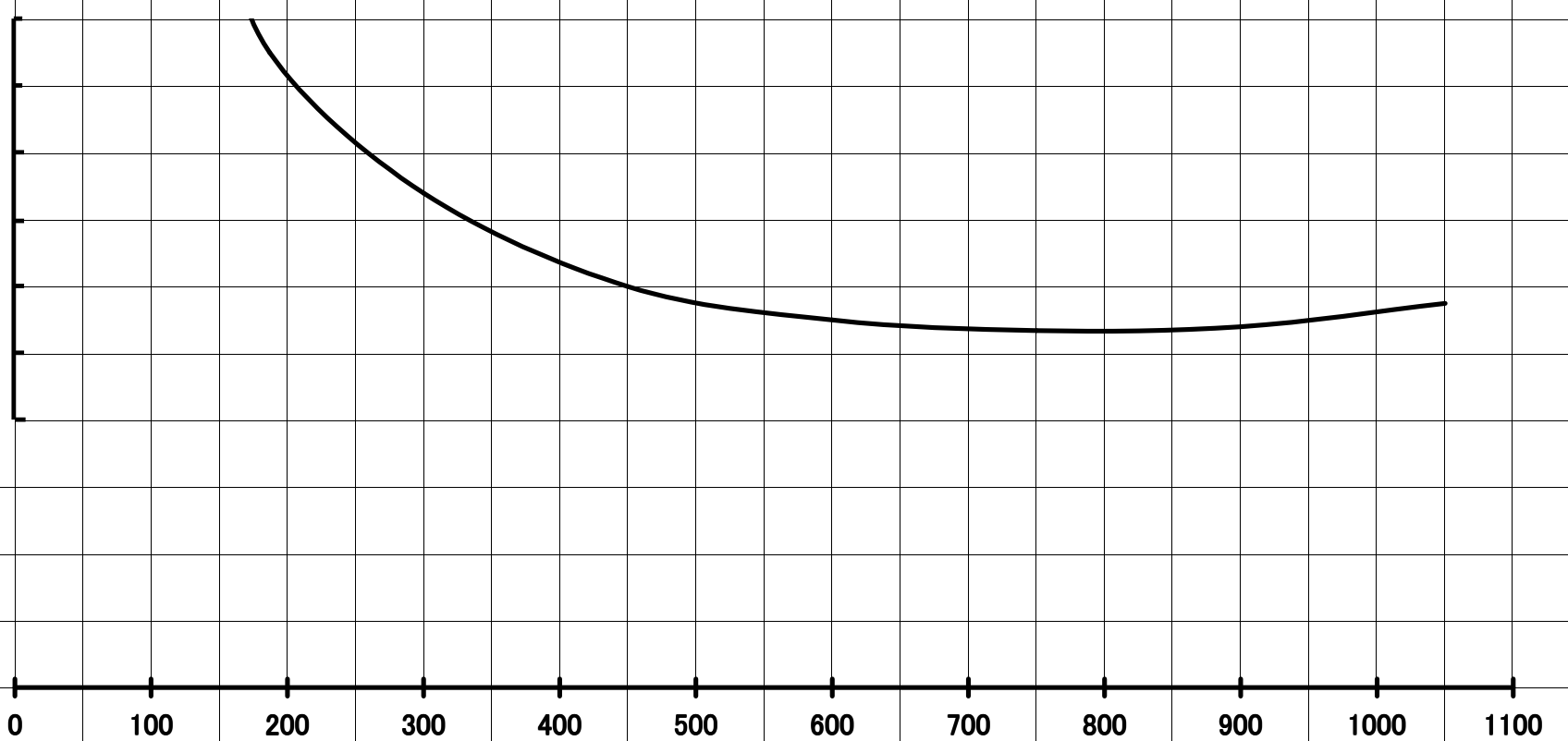

**SPECIFIC FUEL CONSUMPTION
MODEL : S12H-PTA 1500rpm**

- 1. STANDARD : ISO or JIS
- 2. ALLOWANCE : +5%

SPECIFIC FUEL CONSUMPTION g/PS_h

200
190
180
170
160
150
140
190
180
170
160
150
140

0 200 400 600 800 1000 1200 1400 1600

OUTPUT PS

WITH FAN

WITHOUT FAN

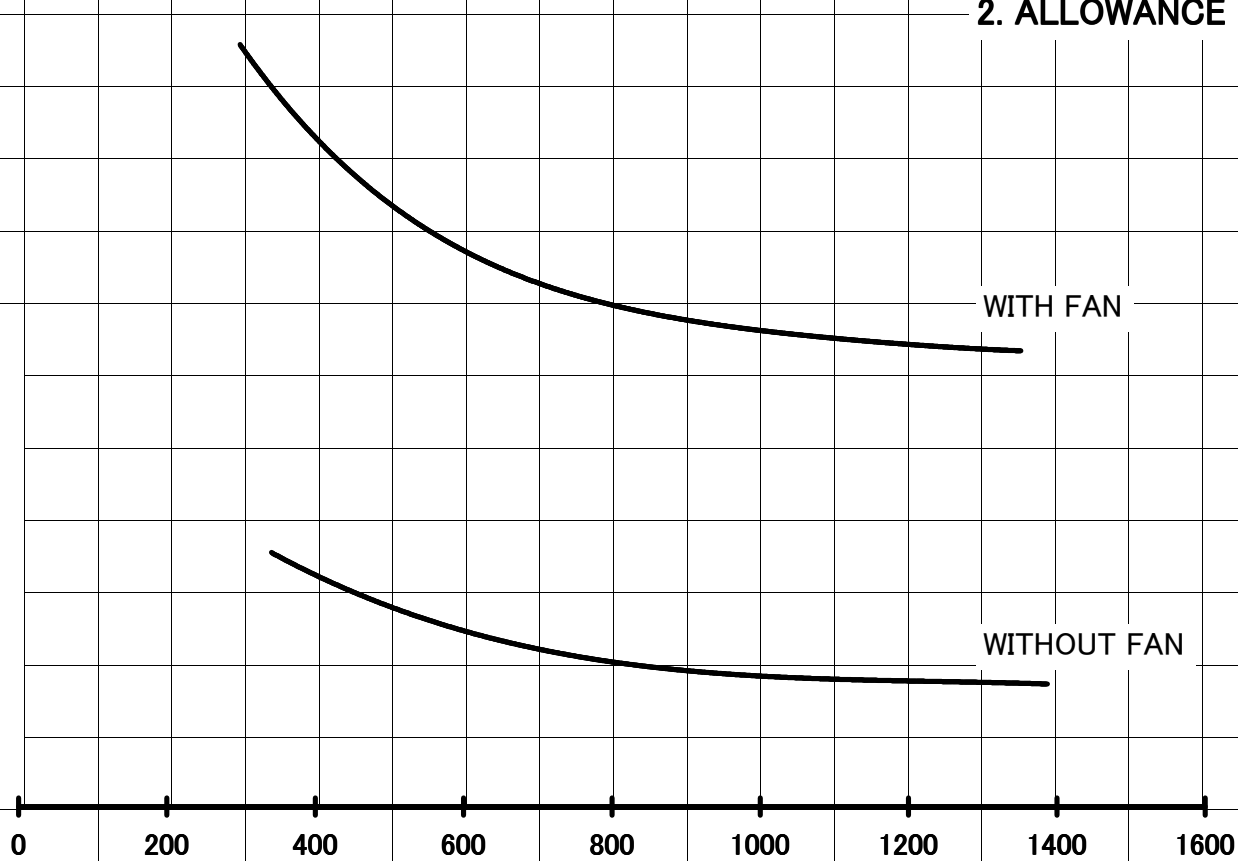

SPECIFIC FUEL CONSUMPTION
MODEL : S12H-PTA 1800rpm

- 1. STANDARD : ISO or JIS
- 2. ALLOWANCE : +5%

SPECIFIC FUEL CONSUMPTION g/PSH

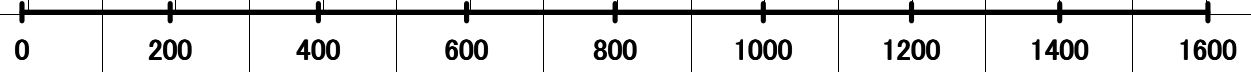
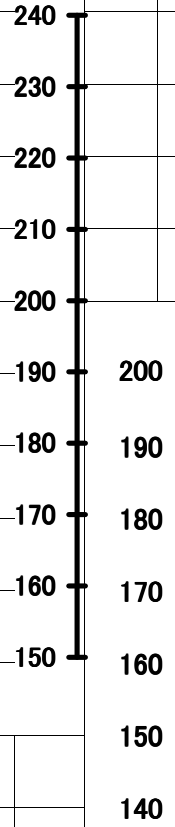

OUTPUT PS

WITH FAN

WITHOUT FAN

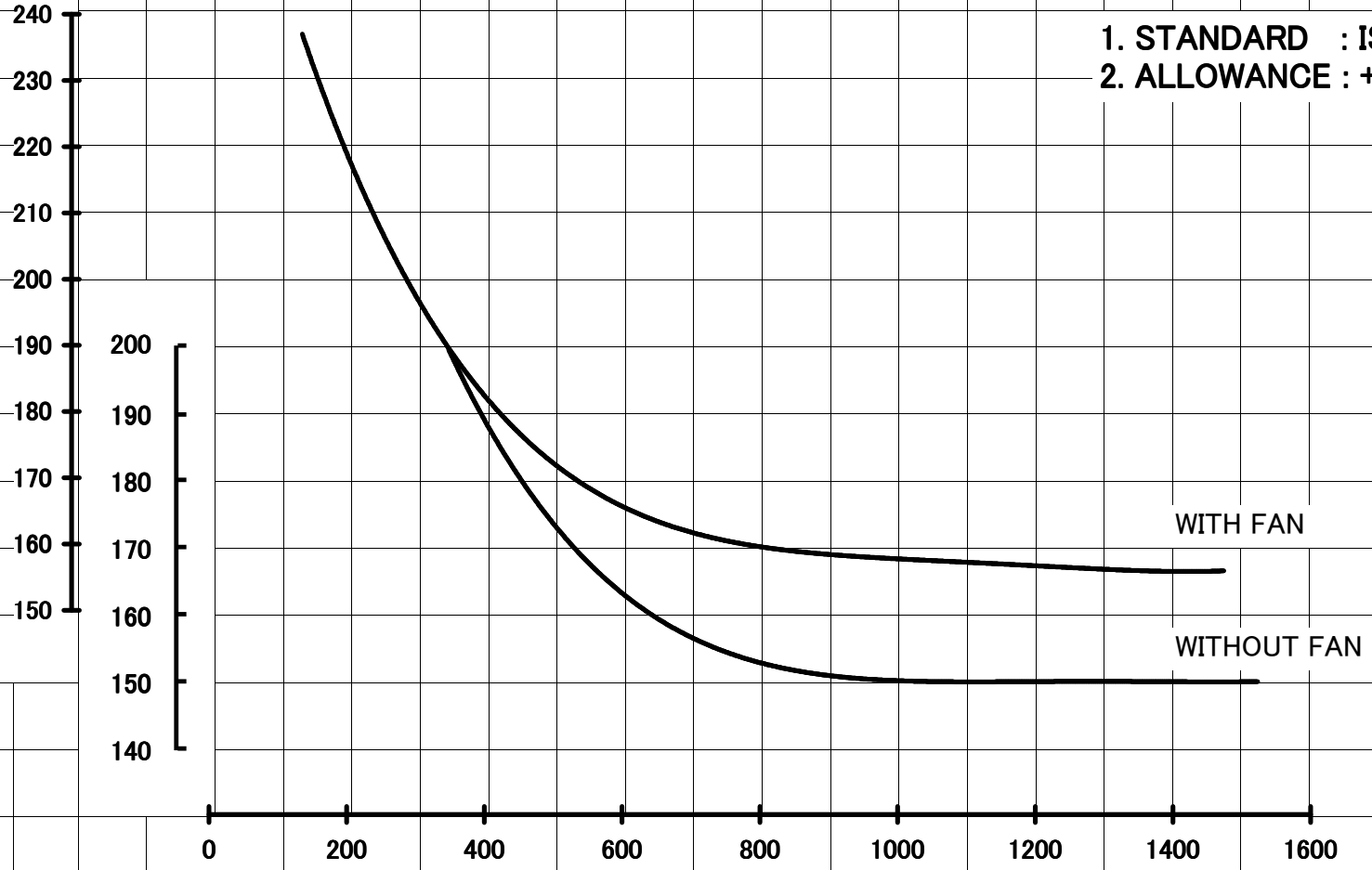

SPECIFIC FUEL CONSUMPTION MODEL : S12R-PTAA2

- 1. STANDARD : ISO or JIS
- 2. ALLOWANCE : +5%

SPECIFIC FUEL CONSUMPTION g/PS_h

200
190
180
170
160
150
140

0

200

400

600

800

1000

1200

1400

1600

1800

2000

2200

OUTPUT PS

1500 rpm

1800 rpm

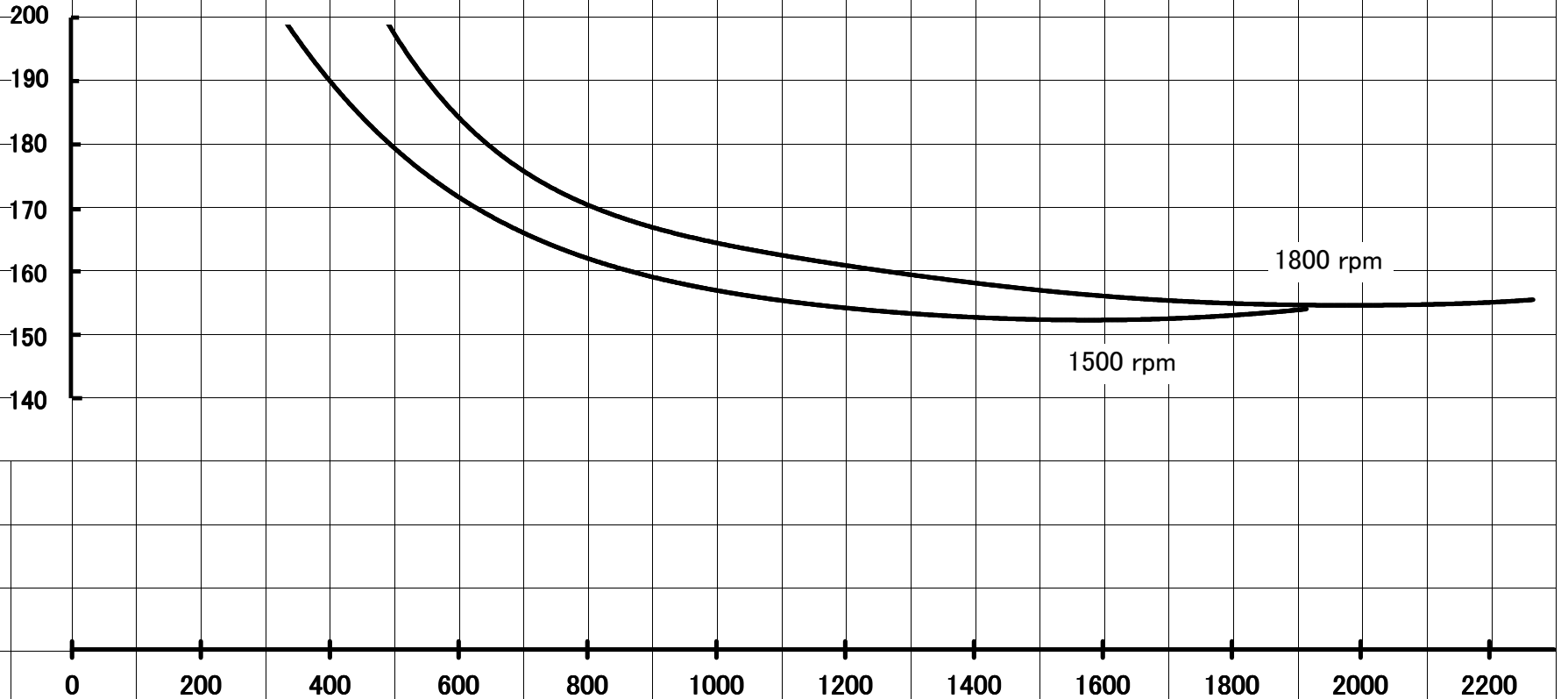

SPECIFIC FUEL CONSUMPTION MODEL : S16R-PTAA2

- 1. STANDARD : ISO or JIS
- 2. ALLOWANCE : +5%

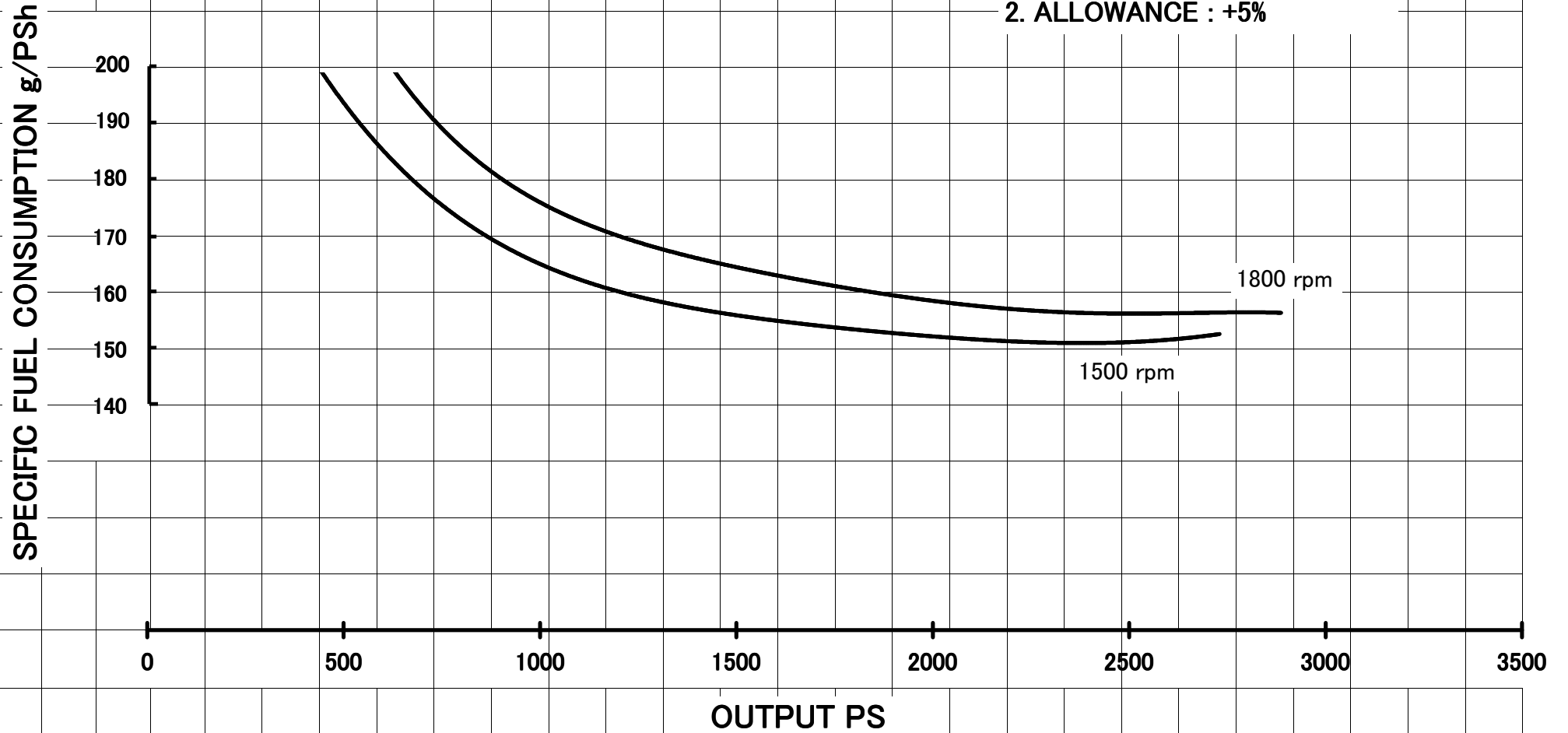

SPECIFIC FUEL CONSUMPTION MODEL : S12R-2 1500rpm

- 1. STANDARD : ISO or JIS
- 2. ALLOWANCE : +5%

SPECIFIC FUEL CONSUMPTION g/PS_h

220
210
200
190
180
170
160
150
140

200
190
180
170
160
150
140

0 200 500 1000 1500 2000 2100

OUTPUT PS

WITH FAN

WITHOUT FAN

PTA2

PTK2

PTA2

PTK2

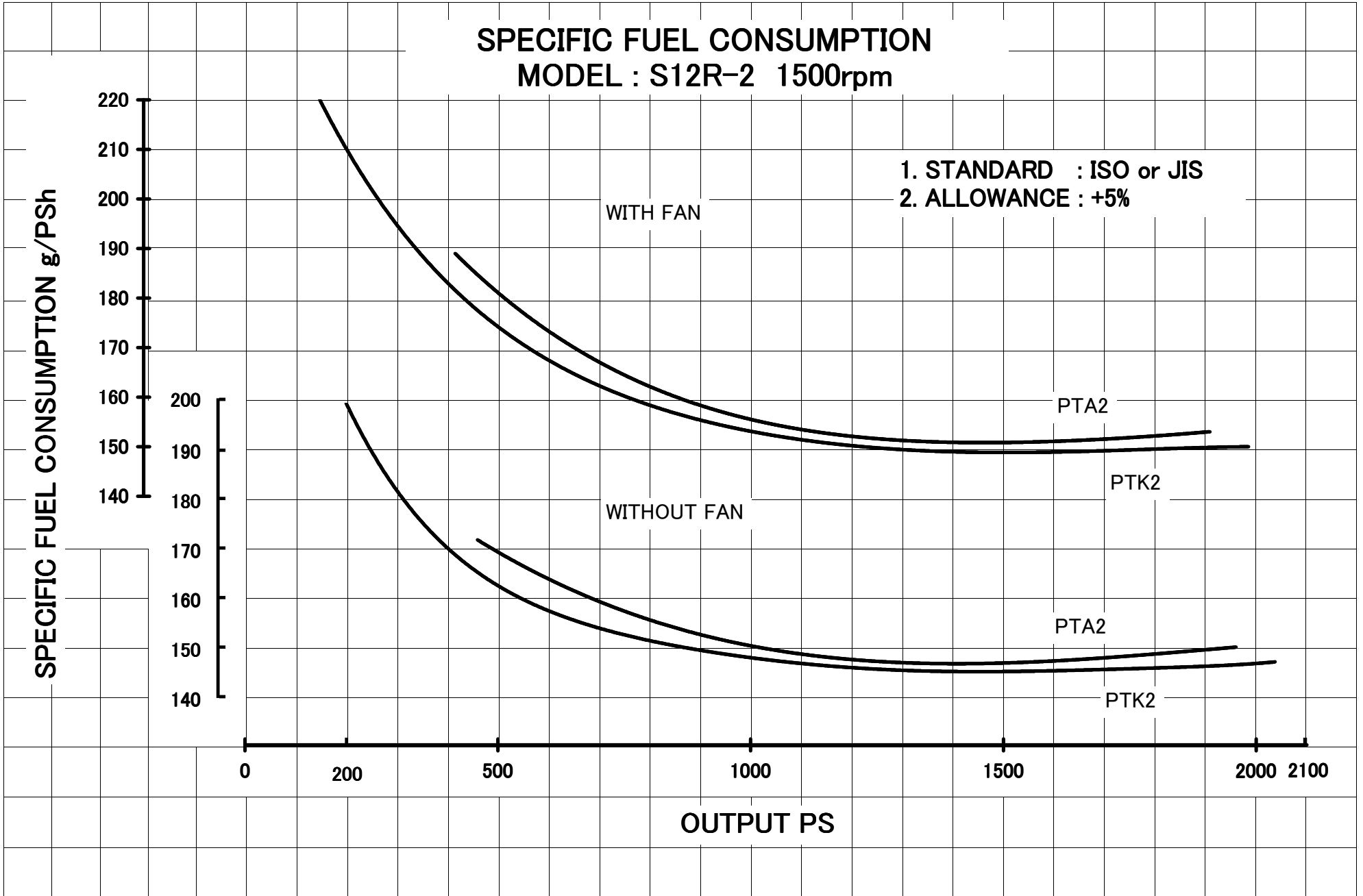

SPECIFIC FUEL CONSUMPTION MODEL : S12R-2 1800rpm

- 1. STANDARD : ISO or JIS
- 2. ALLOWANCE : +5%

